

# Biacore® T100



## Instrument Handbook





# **Biacore<sup>®</sup> T100 Instrument Handbook**

Edition February 2005

Biacore® T100 Instrument Handbook  
Edition February 2005 (Version AA).

Copyright © Biacore 2005.

All rights reserved. No parts of this publication may be reproduced without written permission from Biacore.

Biacore AB reserves the right to make changes to the design and specification of Biacore T100 and to the content of this Handbook without prior notice. Minor differences may occur between illustrations in this Handbook and the appearance of the product.

Biacore is a registered trademark of Biacore AB.

Microsoft and Windows are either registered trademarks or trademarks of Microsoft Corporation in the United States and/or other countries.

Biacore AB  
Rapskatan 7  
SE-754 50 Uppsala  
Sweden

[www.biacore.com](http://www.biacore.com)

# Contents

<b>1.</b>	<b>Introduction</b>	<b>1</b>
1.1	Biacore® T100 system	1
1.2	The Instrument Handbook	2
1.3	Associated documentation	2
1.4	Safety information	2
1.4.1	Rating information	2
1.4.2	Safety labels	3
1.4.3	Safety instructions	4
1.4.4	Disposal procedures	5
1.4.5	Emergency stop routine	5
1.4.6	Restart procedure	6
1.5	Conformance with standards	6
1.5.1	Europe	6
1.5.2	North America	6
1.5.3	External equipment	6
<b>2.</b>	<b>Description</b>	<b>7</b>
2.1	Biacore T100 instrument	7
2.1.1	Buffer tray and left pump compartment	8
2.1.2	Waste and water tray and right pump compartment	9
2.1.3	Sample compartment	10
2.1.4	Sensor chip port	11
2.2	Indicators and switches	12
2.2.1	Status lamps	12
2.2.2	Mains power switch	12
2.2.3	Computer connections	13
2.3	Liquid handling system	13
2.3.1	Overview	13
2.3.2	Autosampler	14
2.3.3	Microplates and racks	15
2.3.4	Liquid supply block	17
2.3.5	Buffer selector valve	18
2.3.6	Buffer degasser	18
2.3.7	Integrated $\mu$ -Fluidic Cartridge (IFC)	19
2.3.8	Flow cells	19
2.3.9	Sample handling	20
2.3.10	Standby mode 20	20
2.4	Detection system	20
2.4.1	Sensor chip	21
2.5	Temperature control	21
2.5.1	Analysis temperature	21
2.5.2	Sample compartment temperature	22
2.6	Software	22

<b>3.</b>	<b>Operation</b>	<b>23</b>
3.1	Starting the system	23
3.2	Preparing the system for a run	24
3.2.1	<i>Preparing buffers</i>	24
3.2.2	<i>Setting up the liquid system</i>	25
3.3	Basic operating procedures	27
3.3.1	<i>Inserting the sensor chip</i>	27
3.3.2	<i>Initiating the liquid handling system</i>	29
3.3.3	<i>Setting the temperature</i>	29
3.4	Preparing samples and reagents	30
3.4.1	<i>Ejecting the rack tray</i>	30
3.4.2	<i>Preparing samples</i>	31
3.4.3	<i>Changing reagent racks</i>	33
3.4.4	<i>Preparing reagents</i>	34
3.4.5	<i>Installing the rack tray</i>	35
3.5	Starting the run	36
3.6	Finishing the run	37
3.6.1	<i>Standby mode</i>	37
3.6.2	<i>Wash buffer tubing</i>	37
3.6.3	<i>Shutdown</i>	37
<b>A.</b>	<b>Installation</b>	<b>39</b>
A.1	General guidelines	39
A.2	Space requirements	39
A.3	Mains power supply	40
A.4	Heating and ventilation	40
A.5	Moving the instrument within the lab	40
A.5.1	<i>Shutting down the system</i>	40
A.5.2	<i>Connecting to mains power</i>	41
A.5.3	<i>Connecting the instrument to the PC</i>	41
A.6	Installing the software	42
<b>B.</b>	<b>Maintenance</b>	<b>43</b>
B.1	Introduction	43
B.2	Maintenance summary	44
B.2.1	<i>User maintenance operations</i>	44
B.2.2	<i>User service operations</i>	45
B.2.3	<i>Preventive maintenance</i>	45
B.3	User maintenance operations	46
B.3.1	<i>Materials required</i>	46
B.3.2	<i>Cleaning the instrument</i>	47
B.3.3	<i>Checking for leaks</i>	48
B.3.4	<i>Cleaning and disinfecting the flow system</i>	50
B.3.5	<i>Normalizing the detector</i>	52

<b>B.4</b>	<b>User service operations</b>	<b>53</b>
B.4.1	<i>System check</i>	53
B.4.2	<i>Superclean</i>	56
B.4.3	<i>Opening the sample compartment</i>	56
B.4.4	<i>Cleaning the sample compartment</i>	57
B.4.5	<i>Cleaning the needle and the liquid supply block</i>	58
B.4.6	<i>Removing the sample compartment box</i>	58
<b>B.5</b>	<b>Shutting down the system</b>	<b>60</b>
B.5.1	<i>Standby</i>	60
B.5.2	<i>Shutdown</i>	60
<b>C.</b>	<b>Troubleshooting</b>	<b>63</b>
<b>C.1</b>	<b>System-related problems</b>	<b>63</b>
C.1.1	<i>Instrument hygiene</i>	63
C.1.2	<i>Instrument considerations</i>	63
C.1.3	<i>Buffer considerations</i>	64
C.1.4	<i>Sample considerations</i>	64
C.1.5	<i>For further help</i>	64
<b>C.2</b>	<b>Assay-related problems</b>	<b>64</b>
C.2.1	<i>Ligand considerations</i>	64
C.2.2	<i>Sample considerations</i>	65
C.2.3	<i>For additional help</i>	65
<b>D.</b>	<b>Specifications</b>	<b>67</b>
<b>D.1</b>	<b>General</b>	<b>67</b>
<b>D.2</b>	<b>Processing unit</b>	<b>67</b>
<b>D.3</b>	<b>Flow cells</b>	<b>68</b>
<b>D.4</b>	<b>System controller and software</b>	<b>68</b>
<b>D.5</b>	<b>Reagent racks</b>	<b>68</b>
<b>D.6</b>	<b>Microplates</b>	<b>69</b>
<b>D.7</b>	<b>Liquid containers</b>	<b>69</b>
D.7.1	<i>Buffer tray</i>	69
D.7.2	<i>Waste and water tray</i>	69
<b>D.8</b>	<b>Chemical resistance</b>	<b>69</b>
<b>E.</b>	<b>Technical description</b>	<b>71</b>
<b>E.1</b>	<b>Detection principle</b>	<b>71</b>
E.1.1	<i>Surface plasmon resonance</i>	71
E.1.2	<i>What SPR measures</i>	72
<b>E.2</b>	<b>Flow system</b>	<b>73</b>
E.2.1	<i>Buffer degasser</i>	74
E.2.2	<i>Cooling unit</i>	74
<b>Index</b>		<b>75</b>





# 1. Introduction

## 1.1 Biacore® T100 system

Biacore T100 from Biacore is a high performance system for real-time biomolecular interaction analysis, using surface plasmon resonance technology (SPR). The system is intended for research and development activities requiring flexibility in assay setup.

Biacore T100 consists of a processing unit, controlled from a PC running Biacore T100 Control Software. The software is wizard based for ease of use, but advanced users can develop and customize methods to suit their needs.

Biacore T100 processing unit provides high sensitivity and a wide dynamic range. The design of the flow cells is optimized for accurate reference subtraction. An integrated buffer degasser eliminates precipitation of air in the flow system.

With an optional GxP package, the Biacore T100 system can be operated in compliance with current GxP regulations.

Sensor chips and a range of chemicals and reagents are available from Biacore.



**Figure 1-1.** *The Biacore T100 system.*

## 1.2 The Instrument Handbook

---

Biacore T100 Instrument Handbook guides you through operation and maintenance of the Biacore T100 system. The handbook also includes a system description, safety instructions, specifications and a brief description of the SPR principle.

## 1.3 Associated documentation

---

*Biacore T100 Software Handbook* describes how to use the software for creating and editing methods, running experiments and evaluating results.

*Online Help* in the Biacore T100 Control Software and Evaluation Software provides detailed assistance on using the software.

*Biacore T100 GxP Handbook* describes how the Biacore T100 system is used with the optional GxP package, for compliance with current GxP regulations.

Other documents describing the technology in more detail are available from Biacore.

## 1.4 Safety information

---

Biacore T100 Processing Unit contains mains voltage and handles liquids that may be hazardous. Before operating or maintaining the system, **you must read this handbook and be aware of the hazards described below**. Follow the instructions provided to avoid personal injuries or damage to the equipment. Do not use the equipment in any other way than described in this manual.

### 1.4.1 Rating information

Instrument ratings are printed on the mains input panel at the rear of the instrument.

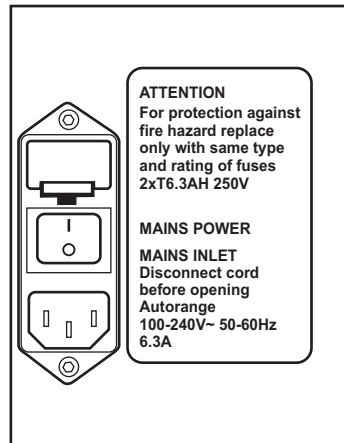

**Figure 1-2.** Rating information on the mains input panel.

### 1.4.2 Safety labels

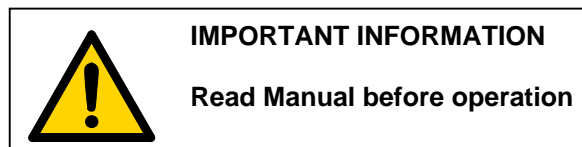

**Figure 1-3.** Safety label.

This safety label is attached to the side panel of the instrument, above the communication ports.

### 1.4.3 Safety instructions

**WARNING!** *HAZARDOUS VOLTAGES*  
Biacore T100 Processing Unit contains mains voltage of up to 265 V ac.

Disconnect mains cord before replacing fuses or opening covers.

**WARNING!** *GENERAL PROCEDURES*  
Always wear appropriate protective clothing during operation and maintenance of Biacore T100.

Use required safety equipment when handling hazardous substances.

**WARNING!** *FLAMMABLE SUBSTANCES*  
Liquids marked as flammable must not be used as running buffer. Any buffer or reagent containing flammable substances must be placed in properly capped vials in the reagent rack. Bear in mind that the temperature in the sample compartment can be as high as 45°C.

**WARNING!** *PINCH HAZARD*  
The rack tray automatically moves into the instrument 1 minute after it has been ejected. Do not place loose objects on the rack tray, and keep your hands and loose items of clothing from the rack tray when it moves into the instrument. A timer on the computer screen indicates when the rack tray will be automatically moved into the instrument.

**WARNING!** *MOVING PARTS*  
Always shut down the instrument and switch off mains power before opening the sample compartment.

**WARNING!** *HEAVY OBJECT*  
Biacore T100 weighs about 60 kg. At least two people are required to lift the instrument.

#### 1.4.4 Disposal procedures

Follow applicable national and/or local regulations for the disposal of chemicals and other materials.

Biacore T100 contains a lithium backup battery, which must not be disposed of in fire. The battery may only be changed by a Biacore Service engineer.

#### 1.4.5 Emergency stop routine

**Caution!**

Do not leave the system in an emergency stop condition. Always follow the restart procedure (see Section 1.4.6) if possible, to restore the processing unit into normal condition.

*If there is time*

To stop a run under controlled conditions before it is complete, choose **Run:Stop Run** from the menu bar. This will stop the run at the end of the current cycle.

*In an emergency situation*

To stop a run immediately in an emergency situation, press **Ctrl-Break (Ctrl-Pause)** on the keyboard.

**Caution!**

Do not use **Ctrl-Break** unless you need to stop all operations immediately (if there is a risk of injury, damage or loss of valuable material).

In an emergency situation:

1. Press **Ctrl-Break** on the keyboard. This will immediately stop all current instrument operations including buffer flow and data collection.
2. In the dialog box that appears, click **Yes** if you want to wash the system with running buffer. You should do this if possible. The wash operation takes about 3 minutes.

Note: If you suspect any error in the system, exit from Biacore T100 Control Software. Turn off power to the instrument with the **MAINS POWER** switch at the back of the unit.

### 1.4.6 Restart procedure

To restart Biacore T100:

1. Turn on mains power and check that the instrument starts normally (see Section 3.1).
2. If the problem persists, run the service tool **System Check** (see Section B.4.1). If any error is detected call your Biacore Service representative.

If you need to clean the liquid handling system, eject the sensor chip and insert a maintenance chip. See Appendix B for further instructions.

## 1.5 Conformance with standards

---

### 1.5.1 Europe

Biacore T100 Processing Unit meets the requirements of the following directives, through the referenced harmonized standards:

European directive	Harmonized standard
73/23/EEC, Low voltage devices	EN 61 010-1 (2001), EN 61 010-1-081 (2002), Safety requirements for electrical equipment for measurement, control and laboratory use.
89/336/EEC, Electromagnetic compatibility	EN 61 326-1 (1997) and amendment A1 (1998) and A2 (2001), EMC requirements for Class B equipment.

### 1.5.2 North America

Biacore T100 Processing Unit meets the following safety standards:

- UL 61010A-1 and CAN/CSA-C.22.2 No 1010.1, Safety requirements for electrical equipment for measurement, control and laboratory use.

### 1.5.3 External equipment

Any external equipment (e.g. computer) connected to the Biacore T100 Processing Unit must comply with the applicable IEC/EN standards.

## 2. Description

### 2.1 Biacore T100 instrument

Biacore T100 instrument is a processing unit with liquid handling, sample handling and detection system, controlled from a PC running Biacore T100 Control Software.

Biacore T100 instrument is used with sensor chips from Biacore. A range of chemicals and reagents designed for use with Biacore T100 is also available.

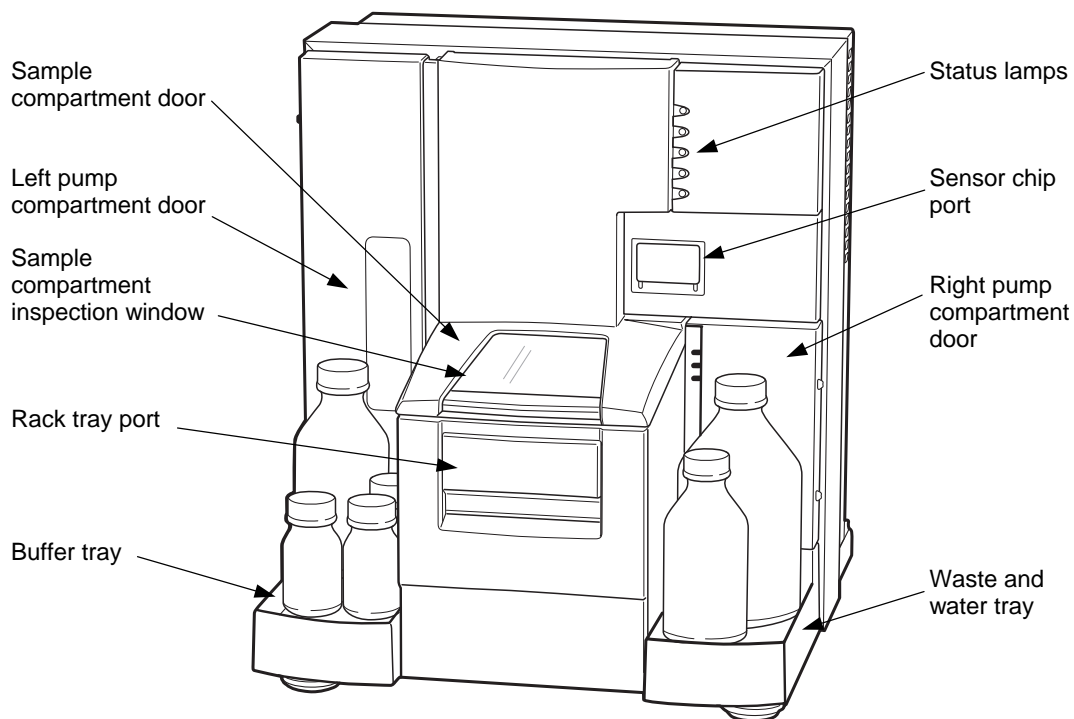

**Figure 2-1.** *Biacore T100 instrument.*

The removable sensor chip is inserted into the sensor chip port and docks into the instrument. Optical detection occurs in flow cells that are formed by the sensor chip and the Integrated  $\mu$ -Fluidic Cartridge (IFC) as part of the docking process.

Bottles containing buffer are placed on the buffer tray. Up to four different buffers can be used. A buffer selector valve determines which buffer flows over the sensor surface.

A waste bottle and a bottle containing water are placed on the waste and water tray.

Reagents and samples are loaded into a reagent rack and a microplate, or into a combined sample and reagent rack. The reagent rack and/or microplate are placed on a rack tray. The rack tray or the sample and reagent rack is inserted into the rack tray port.

During a run, samples and reagents are automatically injected into the detection unit.

### 2.1.1 Buffer tray and left pump compartment

The buffer tray on the left of the instrument holds up to four bottles for running buffer.

The buffer tray is designed to hold standard bottles threaded for screw caps. Four bottles and caps with gaskets are provided with the system: one 1-liter bottle and three 250 ml bottles.

The left pump compartment houses a buffer selector valve, two syringe pumps for sample handling and flow system operation, and a buffer degasser. To open the pump compartment, press on the inner edge of the door.

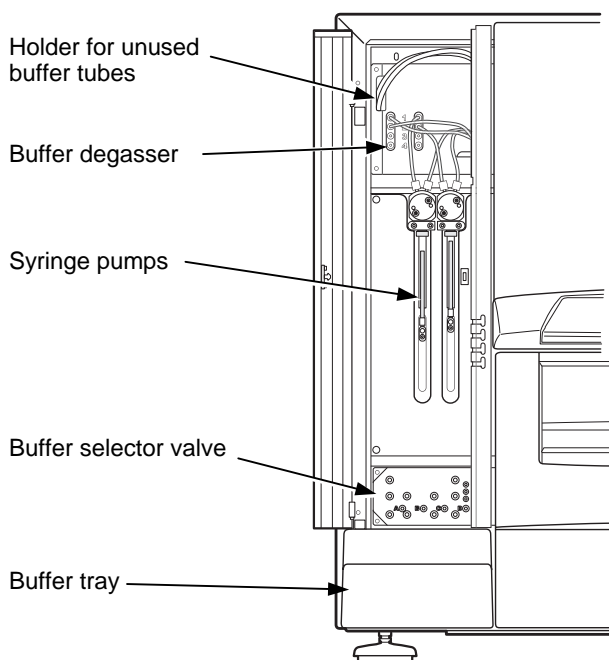

**Figure 2-2.** Left pump compartment, opened.



### ***Buffer tubing and selector valve***

The buffer tubes, marked A, B, C, and D, are connected to the inputs of a buffer selector valve. The selector valve determines which of the buffers is used during a run. Buffer selection is controlled from the software—buffer A is selected by default.

Attach unused buffer tubes to the holder inside the pump compartment door.

### ***Buffer degasser***

The gas content of the running buffer is reduced to a low level by a vacuum degasser. This eliminates the need to degas running buffer before use.

**Note:** The buffer tubing should always be connected via the buffer degasser. Do not disconnect tubes from the degasser even if you use degassed buffer.

## **2.1.2 Waste and water tray and right pump compartment**

The waste and water tray on the right of the instrument holds one 2-liter bottle for waste solutions, and one 500 ml bottle for distilled water.

One 2-liter bottle and cap with tube fittings, and one 500 ml bottle and cap with gasket are provided with the system.

The right pump compartment houses a peristaltic pump for supply of buffer and water to the liquid supply block. To open the pump compartment, press on the inner edge of the door.

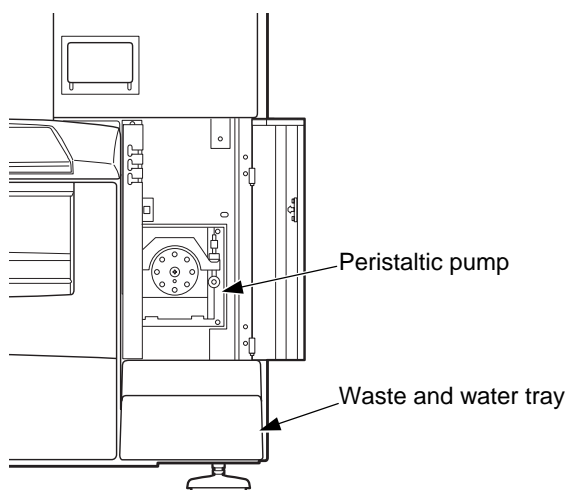

**Figure 2-3.** Waste and water tray and right pump compartment.

The waste tubes are attached with tube fittings to the waste cap. Before starting a run, make sure that the tube fittings are tightened and that the waste bottle is empty.

**Note:** The waste bottle and the cap must be of the same type and size as the ones delivered with the system to avoid pressure disturbances in the liquid handling system. If the outlet is lower than the top of the bottle, there will be a pressure imbalance in the flow system and liquid may be siphoned out of the IFC.

### **2.1.3 Sample compartment**

The sample compartment holds the autosampler and the sample injection unit (see Section 2.3.2). The rack tray port on the front of the instrument is controlled from the software.

#### *Loading samples and reagents*

The user loads the rack tray, carrying the sample and reagent racks, into the rack tray port before starting the run. There is no access to the sample compartment during a wizard run or method run. You may add samples during a manual run.



**Figure 2-4.** Loading the rack tray into the rack tray port.

### *Viewing the samples*

The samples are visible at all times during a run, through the inspection window of the sample compartment door.

Illumination of the sample compartment can be switched on and off through the software command **Tools:Rack Illumination**.

Note: Condensation may occur transiently on the window of the sample compartment door during a temperature change.

#### **WARNING!**

**Do not open the sample compartment door with the mains switch on. The instrument must be off as long as the sample compartment door is open.**

### **2.1.4 Sensor chip port**

The cover to the sensor chip port is controlled through software commands and cannot be opened by hand.

Insert the sensor chip when the port has opened. Close the sensor chip port by pressing on the upper edge. The sensor chip is then docked into the instrument through a software command.



**Figure 2-5.** Inserting a sensor chip.

## 2.2 Indicators and switches

### 2.2.1 Status lamps

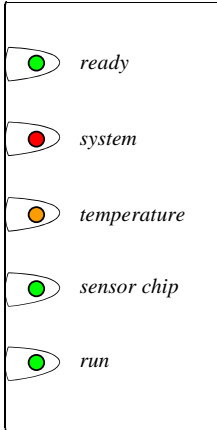

#### Ready (green)

Lights when power is on and the instrument is ready for use.

#### System (red)

This lamp is lit for a few seconds after the power is switched on. If the lamp lights in other circumstances, turn off the instrument and call your Biacore service representative.

#### Temperature (yellow)

Lights steadily when the temperature at the flow cell is stable at the preset temperature.  
Flashes when the temperature is not stable.

#### Sensor chip (green)

Lights when a sensor chip is docked and ready.

#### Run (green)

Lights when the system is running.

### 2.2.2 Mains power switch

The mains power switch is located on the mains input panel, at the rear right of the instrument.

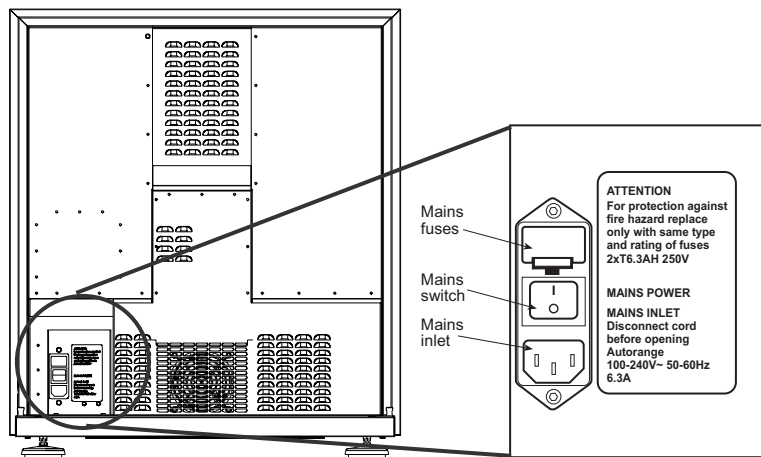
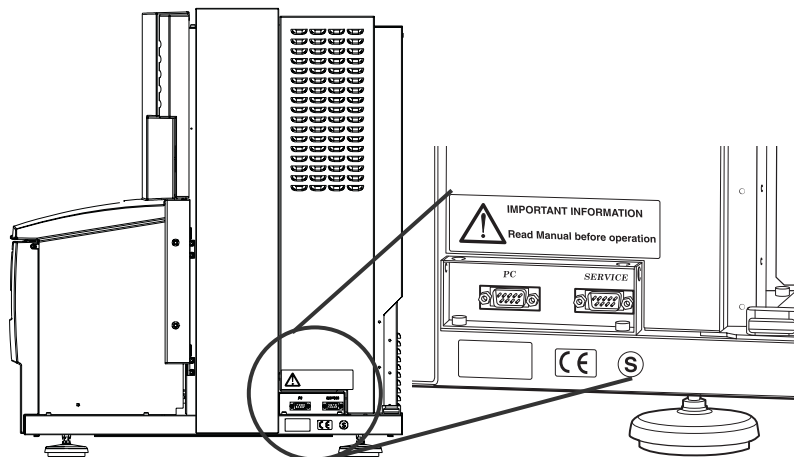

Figure 2-6. Mains input panel at the rear of the instrument.

### 2.2.3 Computer connections

Two computer ports are located on the right-hand side of the instrument. The serial communication cable provided should be connected between the **PC** port and the **COM1** serial port on the computer (on some PCs, the **COM1** port is marked **IOIOIA**).



**Figure 2-7.** Computer ports on the right-hand side of the instrument.

An additional communication cable may be connected between the **SERVICE** port and a second **COM** port on the computer for service purposes.

## 2.3 Liquid handling system

### 2.3.1 Overview

The liquid handling system comprises two syringe pumps, one peristaltic pump, the Integrated  $\mu$ -Fluidic Cartridge (IFC), the injection needle, and the liquid supply block.

The syringe pumps are used for precision delivery of samples, reagents and running buffer to the sensor chip surface via the IFC. The buffer is degassed before entering the syringe pumps. A buffer selector valve determines which of four buffers is used during a run.

The peristaltic pump supplies buffer and water to the liquid supply block. It also pumps waste solution from the liquid supply block to the waste bottle.

Four independent flow cells are formed in the IFC when a sensor chip is docked. Microvalves in the IFC control the liquid flow between the needle and the flow cells.

A simplified diagram of the liquid system, showing delivery of samples and running buffer to the IFC, is shown in Figure 2-8.

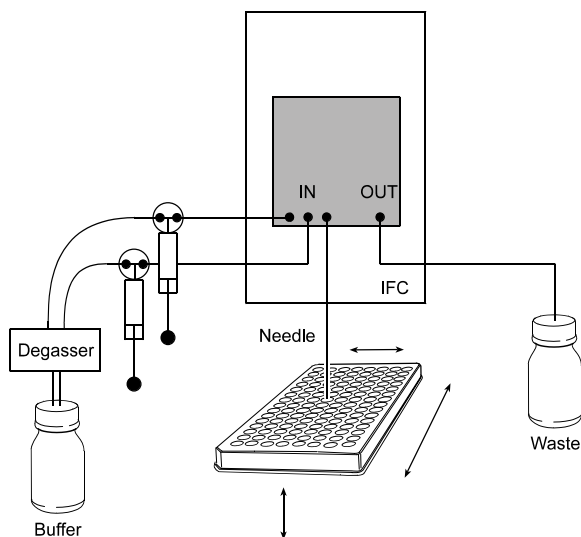

**Figure 2-8.** Schematic diagram of the liquid handling system, showing delivery of samples and running buffer to the IFC.

### 2.3.2 Autosampler

Samples and reagents are held in a microplate and/or rack in the autosampler and are dispensed from there through the injection needle. The sample compartment is temperature-controlled.

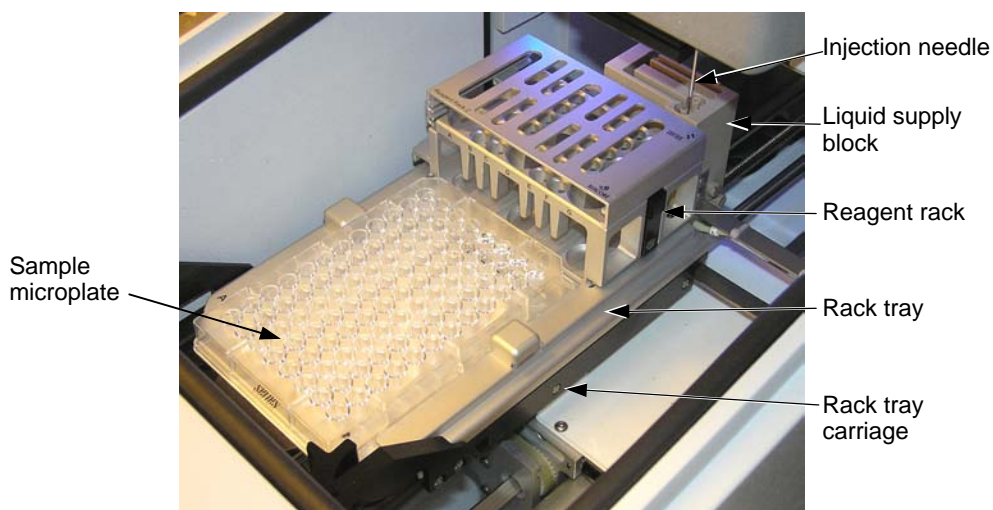
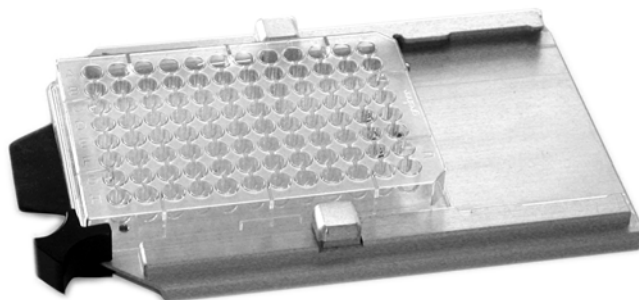

**Figure 2-9.** The autosampler.

### 2.3.3 Microplates and racks

#### *Sample microplate*

Biacore T100 uses standard 96-well and 384-well microplates that are mounted on the rack tray. The microplate is held in position by a spring-loaded catch.



**Figure 2-10.** Rack tray with 96-well microplate.

Biacore T100 is designed to accommodate microplates conforming to the Society of Biomolecular Screening (SBS) standard. Microplates with deep wells are not supported. However, since microplate dimensions are not fully regulated in the standard, compatibility can only be guaranteed for microplates supplied by Biacore. For information about compatibility with other microplates, please contact your local Biacore representative.

#### *Adhesive foil*

The microplate should be covered with adhesive foil to prevent sample evaporation.

**Note:** Use only foil supplied by Biacore. The adhesive substance on the foil is only present between wells. Align the foil with the microplate when attaching it; otherwise the needle may be clogged when penetrating the foil.

#### *Reagent rack*

The reagent rack holds reagents and other solutions. Two reagent rack formats are currently supported:

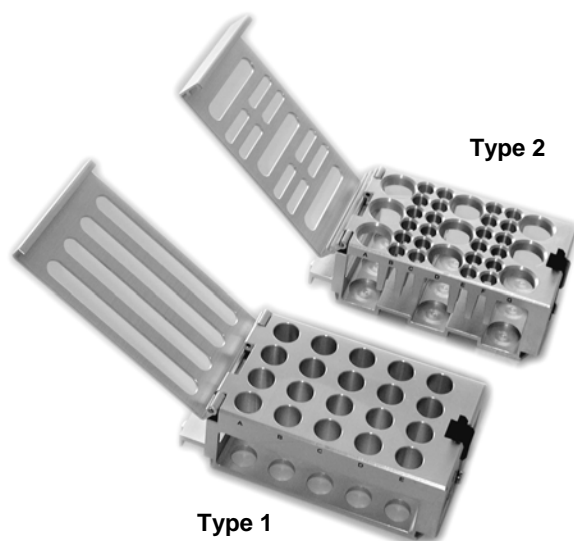

**Figure 2-11.** Reagent racks, Type 1 (bottom) and Type 2 (top).

The rack slides into the holder on the rack tray and clicks into position. When changing racks, make sure that the rack is correctly mounted and that it is pushed firmly into position. (If you attempt to mount the rack in the wrong orientation, it will not click into position and you will not be able to insert the rack tray into the instrument.)

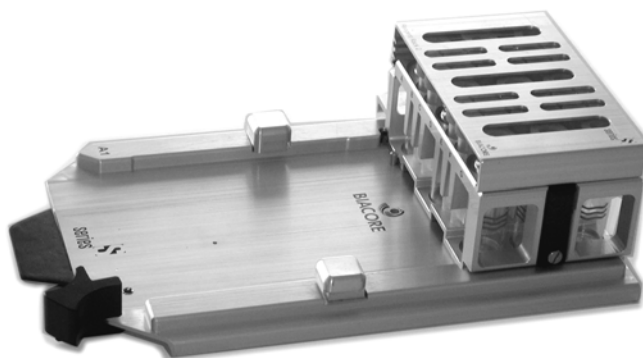

**Figure 2-12.** Reagent rack mounted on the rack tray.

Always use vials with caps as supplied by Biacore. It is important that the injection needle can penetrate the vial caps properly.

#### *Sample and reagent rack*

A combined sample and reagent rack is available. The sample and reagent rack is inserted into the sample compartment instead of the rack tray.

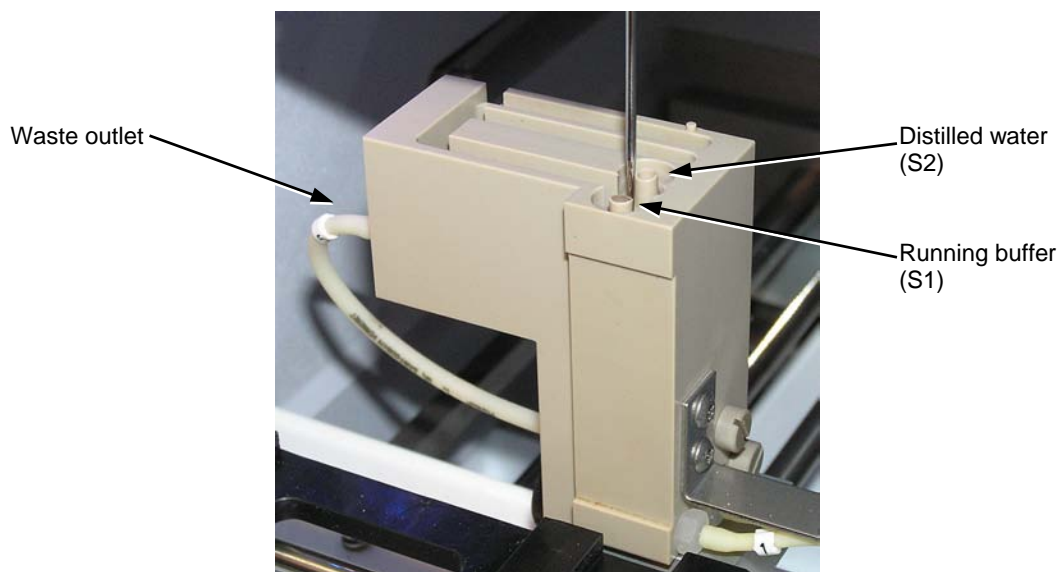



**Figure 2-13.** Sample and reagent rack.

### **2.3.4 Liquid supply block**

The liquid supply block is part of the autosampler assembly. It is used for washing the needle and emptying waste solutions. The peristaltic pump maintains a continuous flow of running buffer and water to the liquid supply block throughout a run, ensuring fresh liquids at all times.



**Figure 2-14.** The liquid supply block.

By washing the needle in fresh buffer, carry-over is avoided. The water is used to rinse the needle and the liquid supply block.

### 2.3.5 Buffer selector valve

The buffer selector valve has four input ports and three output ports, two for the syringe pumps, and one for the peristaltic pump. One out of four buffers is selected and conveyed to all outputs.

The valve is controlled from the software. Buffer A is selected by default. The buffer can be changed during buffer scouting runs or during method-based runs.

Note: All wizards except buffer scouting use Buffer A.

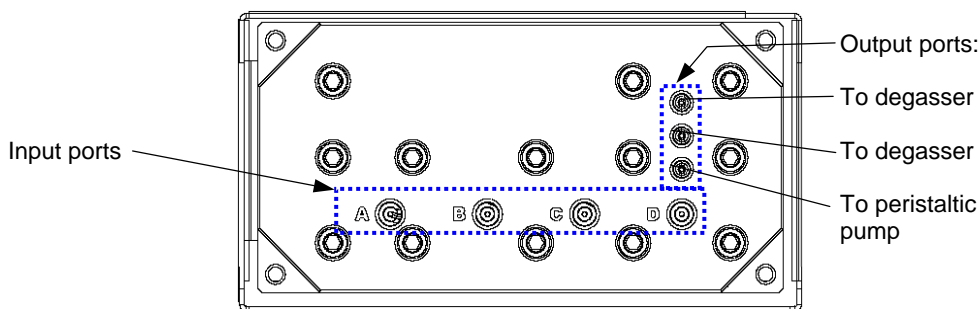

Figure 2-15. Buffer selector valve.

### 2.3.6 Buffer degasser

Two buffer lines pass through independent vacuum chambers in the degasser. Gas molecules dissolved in the liquid diffuse through membrane tubing in the vacuum chamber.

The vacuum pump of the degasser operates as required to keep a low pressure, as soon as the flow system is started.

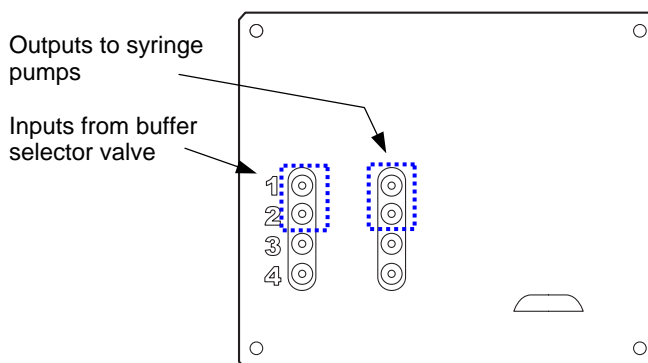

Figure 2-16. Buffer degasser, front panel.

### 2.3.7 Integrated $\mu$ -Fluidic Cartridge (IFC)

The IFC consists of a series of micro channels and membrane valves encased in a plastic housing, and serves to control delivery of liquid to the sensor chip surface.

Samples are transferred from the sample and reagent rack through the needle and into the IFC, which connects directly with the detector flow cells. Effluent from the flow cells is directed to waste.

#### *Injection modes*

There are two injection modes for sample injection with the IFC:

- Single inject
- Dual inject: injection of one sample immediately followed by another

#### *Sample plug technique minimizes dispersion*

A sample plug is created by switching between sample and buffer flow in the IFC.

It is important that the sample is delivered to the flow cell in a well-defined plug with minimum dispersion at the sample-buffer boundaries. To prevent diffusion between buffer and sample, a number of air segments are placed between the buffer and the sample. The number of air segments varies with the type of injection.

### 2.3.8 Flow cells

Four separate flow cells are formed when the sensor chip is docked against the IFC. Precision-cast channels in the surface of the IFC define the flow cells on the sensor chip surface.

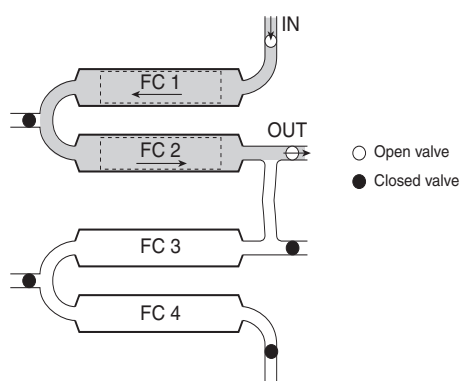

**Figure 2-17.** Simplified diagram showing sample flow through two flow cells.

The IFC allows single or multichannel analysis in up to four flow cells.

The flow cells are optimized for use in pairs, Fc1+Fc2, Fc3+Fc4. The dead volume between the flow cells of a pair is very small, which improves the accuracy of referencing.

Flow cell 1 can be used as in-line reference cell for flow cells 2, 3 and 4, whereas Fc3 can be used for Fc4 only.

### **2.3.9 Sample handling**

During operation, samples and reagents are aspirated from the microplate or rack through the injection needle directly into the IFC. The needle is fixed and the rack tray carriage moves into position as required.

The injection needle and IFC are washed automatically.

### **2.3.10 Standby mode**

When a run is completed, the instrument is automatically placed in standby mode, and a continuous low flow of buffer is maintained through the flow system to prevent accumulation of buffer residues and preserve the ligand.

The default standby period is 4 days. Liquid consumption during standby is approximately 65 ml/24 hours. Buffer tube A is used in standby.

**Note:** Biacore recommends that you use distilled and filtered water instead of buffer to minimize salt deposits. However, if an immobilized sensor chip is docked and should be used later, buffer may be necessary to preserve the sensor surface during standby.

## **2.4 Detection system**

---

The detection system consists of the sensor chip and the optical unit. Molecules that bind to the sensor chip surface affect the reflection of light from a light source within the optical unit. See Appendix E for a description of the SPR principle.

The interaction occurs on the surface of the sensor chip, which forms one wall of the flow cell when the sensor chip is docked on to the IFC.

### 2.4.1 Sensor chip

The sensor chip is a gold-coated glass slide mounted on a supporting frame. The sensor chip is normally enclosed in a protective cassette. For illustration purposes, Figure 2-18 shows the sensor chip removed from the cassette.

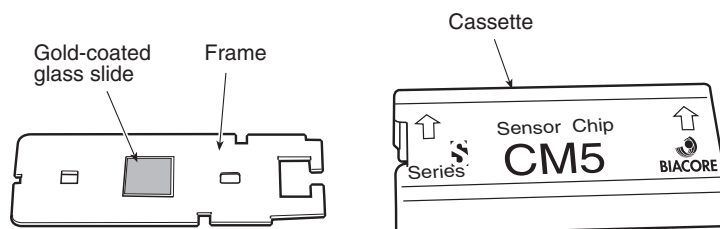

**Figure 2-18.** The sensor chip and the protective cassette.

#### *Sensor chip types*

The most commonly used general-purpose chip, Sensor Chip CM5, has a carboxymethyl dextran matrix covalently bonded to the gold surface of the sensor chip.

- Other sensor surfaces are available for specialized applications, see Biacore Sensor Surface Handbook.

#### *Caution!*

Biacore T100 can only be used with Series S sensor chips from Biacore.

## 2.5 Temperature control

SPR measurements are sensitive to changes in temperature. It is important that a constant temperature is maintained at the sensor chip surface throughout the run.

### 2.5.1 Analysis temperature

The detection area housing the sensor chip is maintained at a precisely controlled temperature (range 4-45°C, max. 20°C below ambient temperature). Runs will not start if the temperature at the sensor surface is not stable. You can choose to ignore or wait for the temperature to stabilize. The **Temperature** lamp on the instrument front panel flashes if the analysis temperature is not stable.

### **2.5.2 Sample compartment temperature**

The sample compartment is maintained at a temperature that may be set from 4-45°C, max. 15°C below ambient temperature.

The sample compartment temperature is set independently of the analysis temperature: injected samples have sufficient time in the needle and IFC to equilibrate to the analysis temperature regardless of sample compartment temperature.

Note: The system does not wait for the sample compartment temperature to stabilize. The **Temperature** lamp shows the analysis temperature, not the sample compartment temperature.

Condensate water may occasionally drip from the instrument during long runs at low temperatures, particularly if ambient humidity is high.

## **2.6 Software**

---

A PC, running dedicated software that handles analysis and presentation of results, controls operation of the processing unit. The software provides a toolbar- and menu-driven user interface. It uses wizards to guide the user through operation steps.

For a description of the software and detailed instructions for use, refer to the separate Biacore T100 Software Handbook.

## 3. Operation

This chapter guides you through the basic operation of Biacore T100. It is assumed that the processing unit and the PC have been installed as described in Appendix A. The chapter is divided into the following sections:

1. Starting the system.
2. Preparing the system for a run.
3. Basic operating procedures
4. Preparing samples and reagents.
5. Starting the run.
6. Finishing the run.

**WARNING!**

Wear appropriate protective clothing when preparing reagents and samples.

### 3.1 Starting the system

---

1. Switch on the instrument. The lamps on the front panel should light in the following sequence:
  - a) All the lamps light for a few seconds and then go out.
  - b) The green **Ready** lamp lights.
  - c) The yellow **Temperature** lamp flashes to indicate non-stabilized temperature, and then is steadily lit when the temperature at the detection unit is stable. The time required for temperature stabilization depends on the set temperature and ambient temperature. The instrument uses the last analysis and sample compartment temperatures set before shutdown as default. Temperature stabilization should not take more than an hour.
2. Switch on the printer and the PC.

3. Start Biacore T100 Control Software: click on the **Start** button in the Windows taskbar and choose **Biacore T100 Control Software** from the **BIA Programs** menu.
4. The software establishes connection with the instrument, which takes about 30 seconds.

## 3.2 Preparing the system for a run

---

### 3.2.1 Preparing buffers

#### *Using standard buffers*

Always keep a high standard of hygiene in the solutions used. Prepare fresh buffer before each run. Standard buffers are available from Biacore as stock solutions<sup>1</sup>. To prepare running buffer, dilute the stock solution with distilled and filtered water. Available buffer solutions include HEPES-buffered saline (HBS) and Phosphate-buffered saline (PBS).

HBS buffers are recommended as running buffer for most general applications. HBS buffers are available with and without EDTA and surfactant.

PBS buffers are recommended as running buffer for small molecule assays. However, phosphate buffer should not be used for interaction systems that require Ca<sup>2+</sup> (calcium phosphate will precipitate at very low Ca<sup>2+</sup> concentrations).

Degassing of buffers is not critical, since Biacore T100 includes an active degasser. The degasser continuously eliminates dissolved air from the running buffer (see Appendix E for further information).

#### *Preparing your own buffers*

All buffers used in Biacore T100, both as running buffer and for sample and reagent preparation, should be filtered through a 0.22 µm filter.

Including a surfactant in the buffer can reduce non-specific adsorption of proteins to the autosampler tube and the IFC channels. Surfactant P20 is available from Biacore.

---

<sup>1</sup> Buffers in 200 ml ready-to-use packs are not recommended for use with Biacore T100.



You may omit surfactant if your sample is detergent-sensitive. However, you may then want to clean the flow system more frequently (see Appendix B, Maintenance).

Use ionic strength at or close to physiological levels (150 mM monovalent ions) to reduce non-specific binding of compounds to the sensor surface.

Tris-based buffers can be used as an alternative for analysis but are not suitable for ligand immobilization using amine coupling.

### 3.2.2 Setting up the liquid system

**WARNING!**

The peristaltic pump may operate at any time during a run or standby. Keep your hands clear of the pump if you open the right pump compartment door during operation.



1. Open the right pump compartment door and check that the clamp of the peristaltic pump is properly fastened: the lever should be in an upright position.
2. Fill a suitable bottle with running buffer. Make sure that the bottle is clean before use. Fit a cap with gasket on to the bottle and place it on the buffer tray. Insert the tube marked **A** through the cap, into the running buffer bottle.

Note: Always use freshly prepared buffer solution. Replace the buffer after every run or at least every 48 hours.

3. If you plan to use different buffers, fill up to three additional bottles with the required buffers. Fit caps with gaskets on to the bottles and place them on the buffer tray. Insert the tubes marked **B**, **C** and **D** into the bottles.

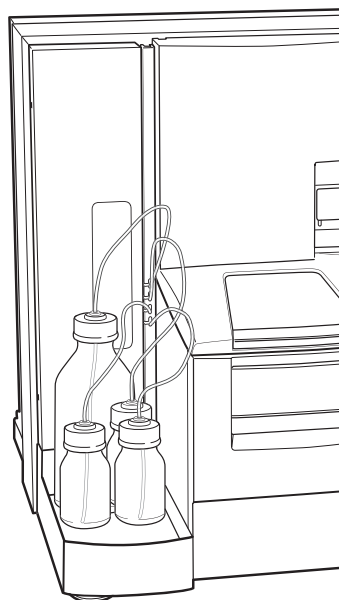

**Figure 3-1.** *Bottles on the buffer tray.*

4. Place unused buffer tubing in the holder inside the pump compartment door.
5. Place a 2-liter bottle for waste solution on the waste and water tray. Fit the cap carrying the waste tubes on to the bottle. Tighten the tube fittings by hand. Do not use a smaller bottle for waste.
6. Fill a 500 ml bottle with distilled and filtered water. Fit a cap with gasket and place it on the waste and water tray. Insert the water tube into the water bottle.

Note: Always use fresh water. Replace before each run, or at least every 48 hours. Do not run the system without water.

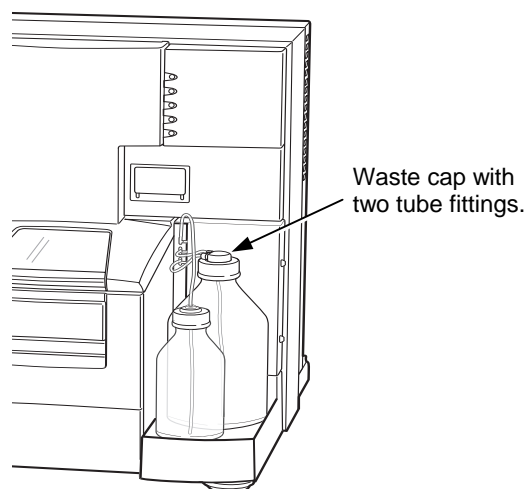



**Figure 3-2.** Bottles on the waste and water tray.

### 3.3 Basic operating procedures

#### 3.3.1 Inserting the sensor chip

Before Biacore T100 can be used, a sensor chip must be docked in the instrument.

1. Make sure that the flow system is properly set up, see Sections 3.2.1 to 3.2.2.
2.  Click on the toolbar icon or choose **Insert Chip** from the **Tools** menu.
3.  If a sensor chip is already docked, click on the **Eject** icon that is shown instead, or choose the **Eject Chip** from the **Tools** menu.

Click **Eject Chip** in the dialog box that appears. This will empty the flow cells and eject the sensor chip.



A countdown timer in the status bar shows the remaining time of the undocking process.

4. The sensor chip port opens and the **Insert Chip** dialog is shown.

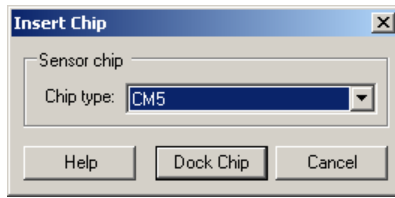

5. Select **Chip type** from the list of available types. This determines the available choice of predefined immobilization methods.

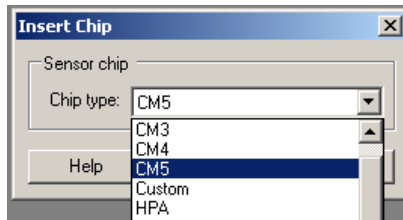

6. Insert the sensor chip and close the port cover:

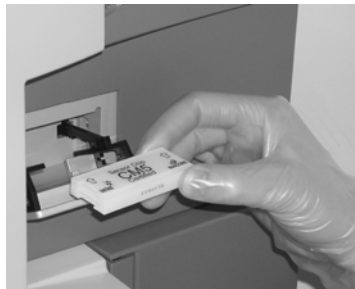

- a. Insert the sensor chip into the sensor chip port (arrow pointing into instrument).
- b. Make sure that the sensor chip is fully inserted.



- c. Close the sensor chip port cover. Press gently until it clicks into position.

**Figure 3-3.** *Inserting the sensor chip.*

7. If you need to open the sensor chip port cover at this stage (for example if you have inserted the wrong chip), click **Cancel**. This will close the **Insert Chip** dialog without docking the chip—you can then choose **Insert Chip** again to open the port cover.
8. Click **Dock chip**. A countdown timer in the status bar shows the remaining time of the docking process. A standby flow of running buffer is started automatically.

### 3.3.2 Initiating the liquid handling system

If the buffer solutions are changed, check the **Prime before run** option in the **System Preparations** dialog, which appears during setup of each wizard run. If you want to prime the system at any other time, choose **Tools:Prime** to ensure that all parts of the liquid handling system are flushed with fresh buffer from tube **A**. This procedure takes 6-7 minutes.

### 3.3.3 Setting the temperature

The temperature at the flow cell is shown in the status window of the Biacore T100 screen. To change the analysis and/or sample compartment temperature:

Choose **Tools:Set Temperature** and enter the required **Analysis temperature**.

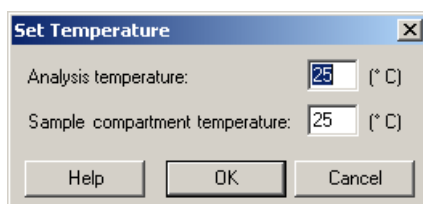
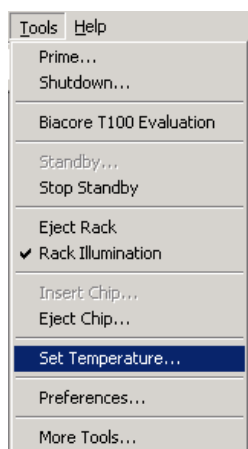

You can start a run before the temperature has stabilized. However, the run will be paused before a step where analysis temperature is critical. A message is displayed and the instrument enters standby, until temperature has stabilized. You can choose to ignore this message, but this is not recommended as the signal is not stable.

## 3.4 Preparing samples and reagents

### 3.4.1 Ejecting the rack tray

The removable rack tray carries one microplate and one reagent rack, and is mounted on the rack tray carriage in the sample compartment. The combined sample and reagent rack is mounted directly on the rack tray carriage.

The rack tray (or the sample and reagent rack) can be ejected in three situations:

- before a run, when preparing samples and reagents,
- during the setup of a run,
- during a manual run.

#### *Ejecting the rack tray before a run*



Click on the toolbar button or choose **Tools:Eject Rack** to eject the rack tray carriage, in order to access the rack tray. The rack tray is ejected and the following dialog box displayed:



**Figure 3-4.** *Eject Rack Tray dialog.*

#### **WARNING!**

The rack tray automatically moves into the instrument 60 seconds after it has been ejected. A timer in the dialog indicates when the rack tray will be automatically moved into the instrument.

### *Removing the rack tray*

1. Press the catch below the front edge of the rack tray to release the rack tray. Lift the rack tray slightly and pull out of the instrument.



- a. Release the rack tray.                      b. Pull out the rack tray.

**Figure 3-5.** *Removing the rack tray from the instrument.*

2. When you click on **OK** in the **Eject Rack Tray** dialog, the rack tray is moved into the instrument immediately.

### *Removing the sample and reagent rack*

Remove the sample and reagent rack using the procedure described above for the rack tray.

### **3.4.2 Preparing samples**

1. Dispense the samples into the sample microplate, or the sample and reagent rack, as shown in the **Rack Positions** window.
2. Check that all samples are at the bottom of the wells. It is easy to trap air bubbles at the bottom of the wells in 384-well microplates: make sure all such air bubbles are removed.
3. Cover the used sample wells with recommended adhesive foil, available from Biacore. This prevents evaporation from the samples during analysis.
4. Open the catch on the rack tray and slide the microplate onto the rack tray. Place the microplate with well **A1** facing towards the front of the rack tray.

**Caution!**

Make sure that you install the microplate with well **A1** facing the front of the microplate. Otherwise the sample order will be incorrect.

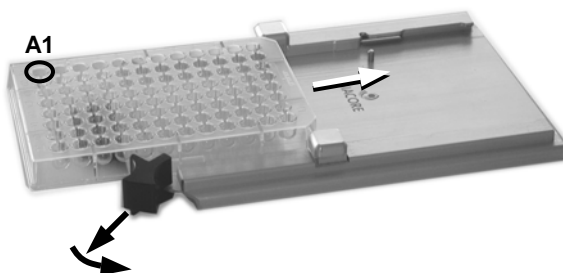

**Figure 3-6.** *Placing the sample microplate on the rack tray.*

5. Close the catch and make sure that the microplate is properly seated on the rack tray.

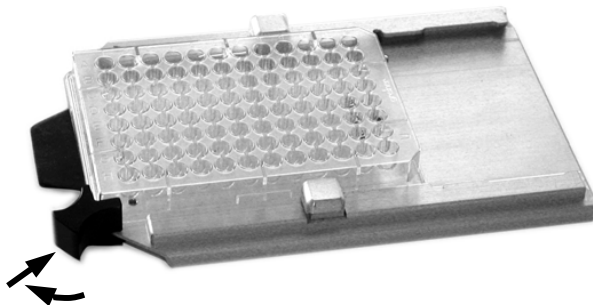

**Figure 3-7.** *Fastening the sample microplate on the rack tray.*



### *Adjusting the rack tray*

To accommodate some brands of microplates, it may be necessary to adjust the retainers on the rack tray. Contact your Biacore representative for more information. Adjust the retainers as follows:

1. Loosen the screws underneath the rack tray and turn the retainers through 90° to accommodate the microplate.
2. Tighten the screws again after the adjustment.

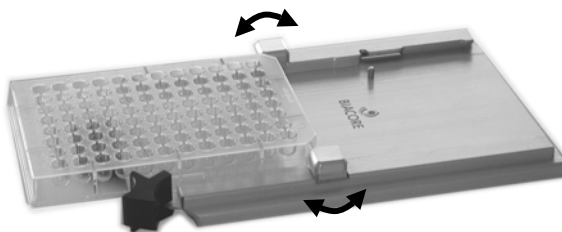

**Figure 3-8.** *Adjusting the rack tray.*

### **3.4.3 Changing reagent racks**

1. Remove the rack from the rack tray by pushing firmly at the rack cover.

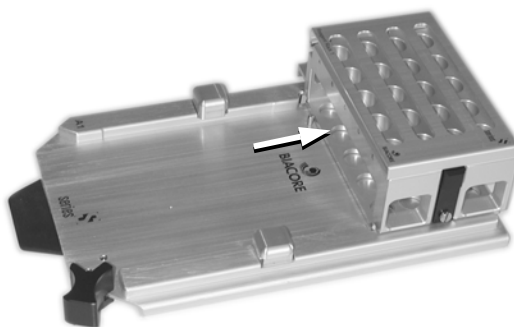

2. Slide the new rack into the holder on the rack tray. Make sure that it is correctly oriented. If the rack is inserted the wrong way the rack tray will not fit into the sample compartment.

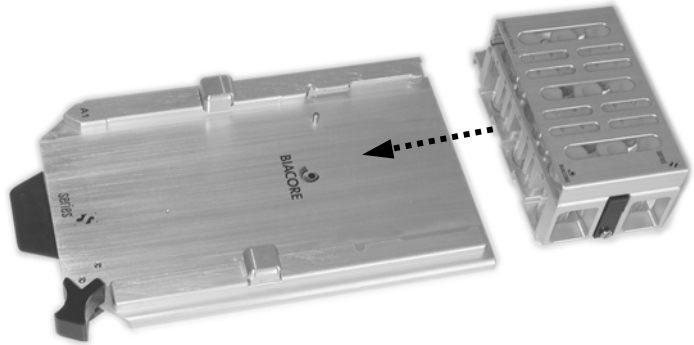

3. Push the rack until it snaps into position on the rack tray. Make sure that the rack is properly in place.

### 3.4.4 Preparing reagents

1. Open the cover of the reagent rack, or the sample and reagent rack.
2. Cap the vials and place in the reagent rack as shown in the **Rack Positions** window. Use only caps supplied or approved by Biacore for use in Biacore T100.

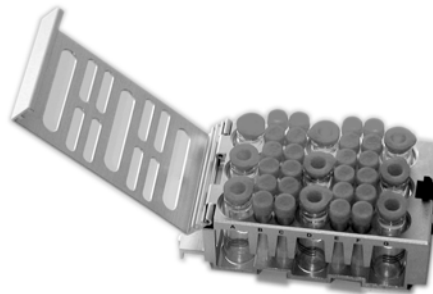

3. Close the reagent rack cover and press until it snaps shut. Make sure that the cover is completely closed.

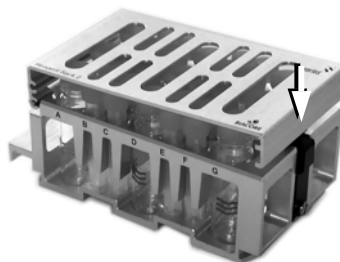

### 3.4.5 Installing the rack tray

1. If the rack tray port is not open when you are ready to install the rack tray, eject the rack tray carriage as described in Section 3.4.1.
2. Insert the rack tray. Press gently until the rack tray snaps into place.
3. The rack tray automatically moves into the instrument 60 seconds after it has been ejected. When you click on **OK** in the **Eject Rack Tray** dialog, the rack tray is moved into the instrument immediately.

An alert will be shown if the rack tray is not inserted properly: make sure that the rack tray has snapped into place and click **OK**.



**Figure 3-9.** Loading the rack tray into the sample compartment.

### *Installing the sample and reagent rack*

Insert the sample and reagent rack using the procedure described above for the rack tray.



**Figure 3-10.** Loading the sample and reagent rack into the sample compartment.

## 3.5 Starting the run

---

When docking of the sensor chip is ready, a standby flow of running buffer is started.

- To start a wizard run, choose **Run:Wizard**. Choose the type of run and select a template. Follow the step-by-step instructions of the wizard.
- To start a method run, choose **Run:Method**. Open a method or build a new method.
- Before you start a manual run, run **Tools:Prime** and **Tools:Normalize**. To start a manual run, choose **Run:Manual run**. Define the flow path and click **Start**.

For details of the different types of run, refer to *Biacore T100 Software Handbook*.

---

## 3.6 Finishing the run

---

### 3.6.1 Standby mode

When a run is completed, the instrument is automatically placed in standby mode: a continuous low flow of buffer (using buffer tube **A**) is maintained through the flow system to prevent accumulation of buffer residues.

The default standby period is 4 days. Liquid consumption during standby is approximately 65 ml/24 hours.

Note: Biacore recommends that you use distilled and filtered water instead of buffer to minimize salt deposits. However, if an immobilized sensor chip is docked and should be used later, buffer may be necessary to preserve the sensor surface during standby.

### 3.6.2 Wash buffer tubing

The maintenance tool **Wash Buffer Tubing** washes all buffer tubing with BIAdesorb solution to remove adsorbed material. Run this tool when you change from buffers containing substances that tend to adsorb to the tubing, e.g. detergent or BSA.

If you have used buffer tubes **B**, **C** or **D** and do not plan to use them in coming runs, run the maintenance tool **Empty Buffer Tubing** to wash and empty the buffer tubing, then place unused tubes in the holder in the left pump compartment.

For details of buffer tubing maintenance, see Appendix B.

### 3.6.3 Shutdown

If you want to shut down the instrument completely, see instructions in Appendix B.



# A. Installation

## A.1 General guidelines

Biacore T100 will be installed by a Biacore representative. The site should be prepared for the installation as described in Sections A.2 to A.4. If you need to move the instrument after installation, follow the instructions in Section A.5.

## A.2 Space requirements

The size of the processing unit is indicated in Figure A-1. At least 20 cm clearance is required behind and above the processing unit to allow adequate air circulation.

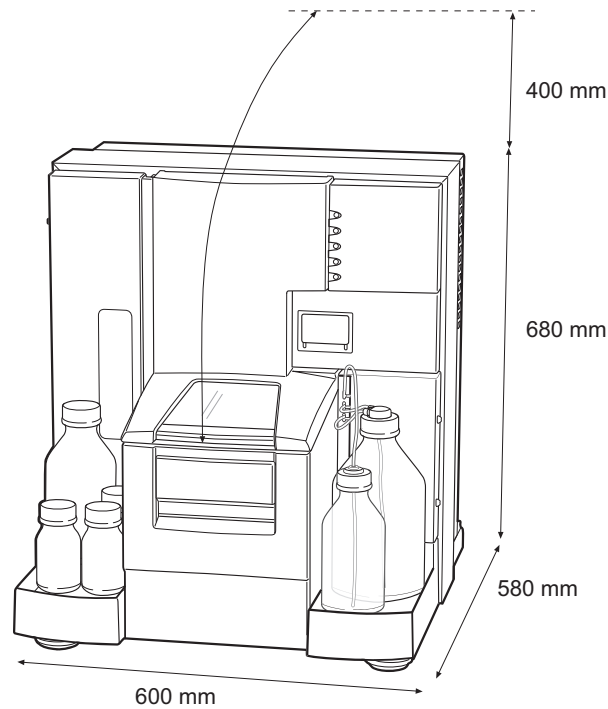

**Figure A-1.** Space requirements for Biacore T100.

### A.3 Mains power supply

---

The processing unit and the PC with printer require mains power outlets with protective earth as specified in Table A-1.

Mains voltage	100-240 Vac (autorange), 50-60 Hz
Power consumption:	
processing unit	maximum 6.3 A
PC and monitor	see manufacturer's manual
printer	see manufacturer's manual

**Table A-1.** Mains power requirements.

### A.4 Heating and ventilation

---

For proper operation, Biacore T100 requires an ambient temperature of 18-33°C and a relative humidity below 85%. Make sure there is adequate circulation around the instrument.

### A.5 Moving the instrument within the lab

---

#### **A.5.1 Shutting down the system**

Before moving the system:

1. Shut down the instrument completely (See Appendix B, Section B.5).
2. Shut down the computer.
3. Disconnect the serial communication cable.
4. Place the instrument in a location that complies with the requirements in Sections A.2 to A.4.

Note: When moving to a new site, contact your Biacore representative.



### A.5.2 Connecting to mains power

**Caution!**

Do not turn on the mains power switches before all connections are made.

1. Connect the mains power cord delivered with the instrument, to the **MAINS INLET** connector on the rear panel. Connect the other end to a mains outlet with protective earth.
2. Check that any mains voltage selectors on the PC and peripheral equipment are set correctly.
3. Install the PC and peripheral equipment according to the respective instruction manuals.

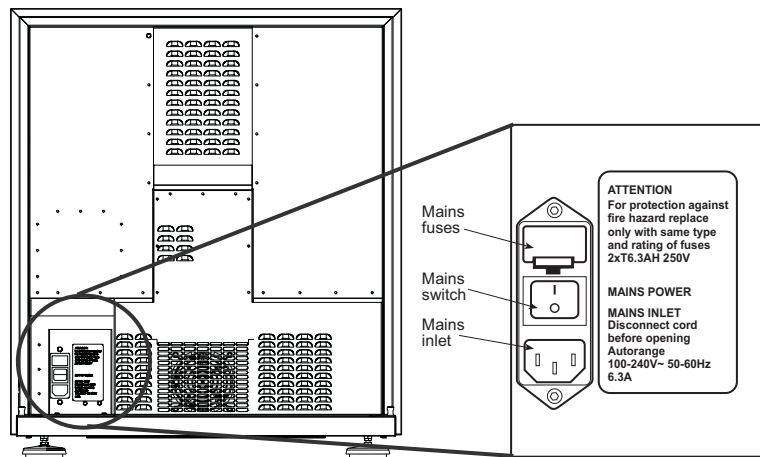

Figure A-2. Mains input panel at the rear of the instrument.

### A.5.3 Connecting the instrument to the PC

Connect a serial communication cable between the **COM1** (or **IO1OIA**) port of the PC, and the **PC** connector on the rear panel of the processing unit.

The **SERVICE** connector is connected to **COM2** on the computer.

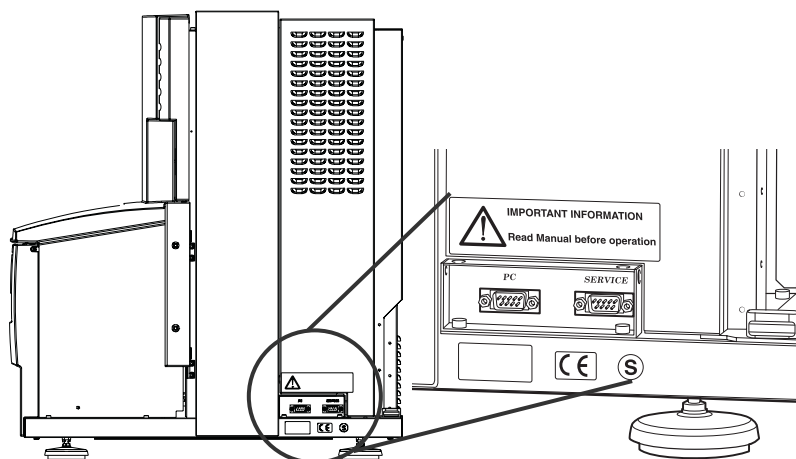

Figure 3-3. Computer ports on the right-hand side of the instrument.

## A.6 Installing the software

Biacore T100 Control Software and Biacore T100 Evaluation Software are supplied on CD. The software will be pre-installed on delivery. If the software needs to be re-installed for any reason:

1. Turn on the PC.
2. Insert the Biacore Software CD in the CD drive and follow the instructions on the screen.
3. For software registration, you need the Product Key which is printed on the back of the CD case. Biacore software cannot be installed without a valid Product Key.
4. After restart, the **Biacore T100** software icons appear in the **BIA Programs** group in the Windows **Start** menu.

## B. Maintenance

### **WARNING!**

- Always wear appropriate protective clothing during operation and maintenance.
- Use required safety equipment when handling hazardous substances.
- If the instrument is contaminated with biohazards, please contact your local Biacore service representative for further information about decontamination procedures.

### B.1 Introduction

Regular maintenance of Biacore T100 is essential for reliable results. It is important to keep the instrument free from contamination such as microbial growth and adsorbed proteins in the liquid handling system.

Regular maintenance should be performed at three levels:

- User maintenance operations, supported by the **Maintenance Tools** software functions.
- User service operations, supported by the **Test Tools** and **Service Tools** software functions.
- Preventive maintenance operations, which should be performed on a regular basis by your Biacore service representative.

Software tools for maintenance and service are accessed by choosing **More Tools** from the **Tools** menu. This command opens the **Tools** dialog (see Figure B-1).

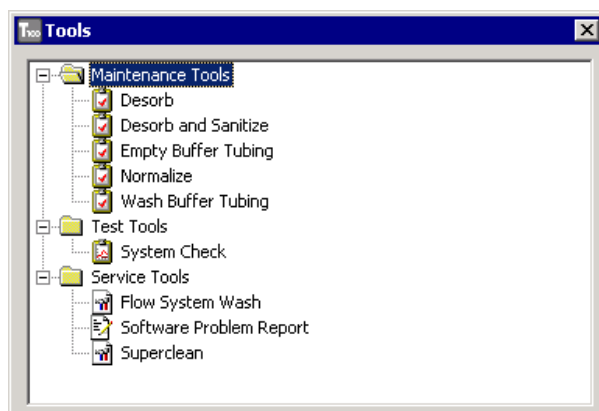

**Figure B-1.** *The More Tools menu.*

This chapter summarizes user maintenance and describes the use of software tools for user maintenance and service procedures. If more extensive maintenance or service of the instrument is required, please contact your local Biacore Service representative.

Make sure that a Biacore Maintenance Kit, type 2 is available before starting maintenance procedures (see Section B.3.1).

## B.2 Maintenance summary

Regular checks and maintenance should be done according to the schedule below.

### B.2.1 User maintenance operations

See Section B.3 for user maintenance instructions.

Interval	Action	Section
Daily/after each run	Empty the waste bottle	
Weekly	Inspect tube fittings and pumps, check for leaks	B.3.3
	Clean the flow system ( <b>Desorb</b> )	B.3.4
Monthly	Clean the instrument cover	B.3.2
	Clean and disinfect the flow system ( <b>Desorb and Sanitize</b> )	B.3.4
	Inspect the needle and the liquid supply block	B.4.5
	Inspect the sample compartment, look for signs of flooding	B.4.3
	Run <b>System Check</b>	B.4.1

**Table B-1.** Schedule for user maintenance operations.

### **B.2.2 User service operations**

In addition to the user maintenance operations, you may need to perform some service operations using the available tools:

<b>Service tool</b>	<b>Description</b>	<b>Section</b>
<b>Superclean</b>	This is a powerful tool which can be used for extensive cleaning if the <b>Desorb and Sanitize</b> procedure is not sufficient to clean the flow system	B.3.4
<b>System Check</b>	Always run <b>System Check</b> before calling Biacore Service	B.4.1
<b>Software Problem Report</b>	Run this tool if you experience problems with Biacore T100 Software which do not have a readily apparent solution	

**Table B-2.** Tools for user service operations.

### **B.2.3 Preventive maintenance**

To ensure correct performance of Biacore T100, preventive maintenance should be done regularly by a qualified Biacore Service representative. During the maintenance visit, worn parts are replaced and all vital modules of the Biacore T100 system are tested.

The following components are always replaced:

- IFC
- Opto interface
- Syringe pump tips
- Peristaltic pump tubing

## B.3 User maintenance operations

### B.3.1 Materials required

Biacore Maintenance Kit, type 2 contains the materials needed for routine user maintenance.



**Figure B-2.** Biacore Maintenance Kit, type 2.

#### *Kit contents*

Solution/Item	Specification
BIAdesorb solution 1	0.5% (w/v) sodium dodecyl sulphate (SDS), two bottles of 95 ml
BIAdesorb solution 2	50 mM glycine pH 9.5, two bottles of 95 ml
BIAtest solution	15% sucrose in HBS-N buffer with 3 mM EDTA, one bottle of 65 ml
BIAdisinfecant solution (conc.)	Sodium hypochlorite with 8-12% active chlorine, three bottles of 10 ml
BIANormalizing solution	70% (w/w) glycerol, one bottle of 90 ml
HBS-N buffer 10X	One bottle of 50 ml
Sensor Chip Maintenance	One sensor chip

**Table B-3.** Contents of Biacore Maintenance Kit, type 2.

**Storage**

All solutions except BIAdesorb solution 1 should be stored at +4-8 °C. BIAdesorb solution 1 should be stored at room temperature.

**WARNING!**

BIAdisinfecant solution is corrosive. The solution should be diluted shortly before use as described in the Instructions for Use provided with the maintenance kit.

In addition to the maintenance kit you will need the following accessories:

- Distilled and filtered water
- 70% (v/v) ethanol
- Clean, lint-free cloths
- Series S Sensor Chip CM5

**Caution!**

Some maintenance procedures will destroy the ligand on a prepared sensor chip. Always use the separate Sensor Chip Maintenance that is included in the maintenance kit.

**B.3.2 Cleaning the instrument**

If necessary, clean the cover of the processing unit with a moist cloth. Use water or a mild detergent.

The buffer tray and the waste and water tray can be removed for cleaning.

If necessary, clean the waste bottle cap as follows:

1. Unscrew the cap from the waste bottle.
2. Loosen the tube fittings and remove the tubes from the cap.
3. Rinse the cap in deionized water.
4. Attach the tubes to the cap and tighten the fittings firmly.

### B.3.3 Checking for leaks

Once a week, check that there are no liquid or salt deposits at the following positions (see Figure B-3):

- Syringe pump: tube fittings, inside the pump barrel, at the plunger drive (for details, see Figure B-4)
- Buffer selector valve: tube fittings
- Degasser: tube fittings
- Peristaltic pump: tube fittings below the pump

If you find leaks at tube fittings, clean with water and tighten the connections.

If you find leaks in either of the syringe pumps, call your Biacore Service representative.

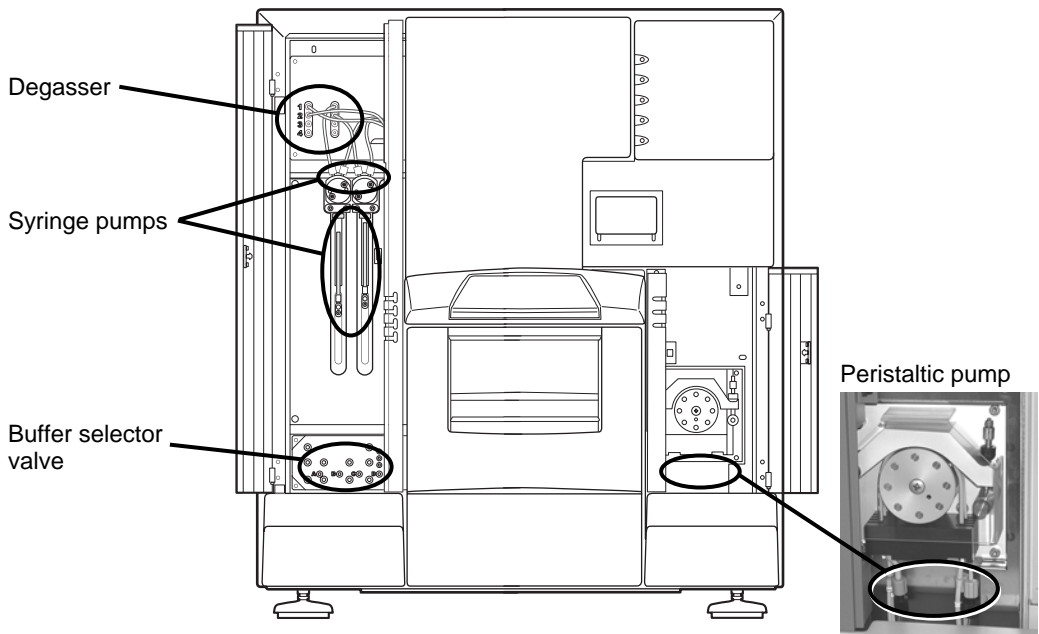
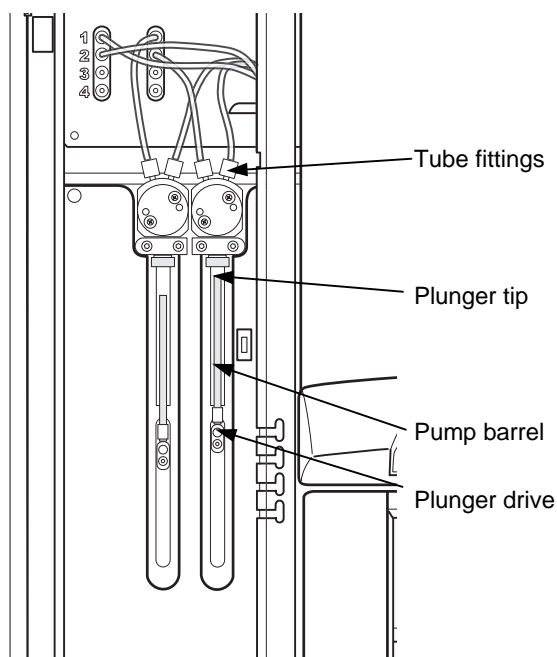

Figure B-3. Leakage check points.





**Figure B-4.** Checking the syringe pumps for leakage.

### *Cooling unit*

Condensate water may drip from underneath the instrument during long runs with cooling below ambient temperature. Wipe off any water from the bench. This is not a leakage but a sign of normal operation of the cooling unit.

### B.3.4 Cleaning and disinfecting the flow system

Tools for cleaning and disinfecting the flow system are available under **Maintenance Tools** in the **More Tools** menu.

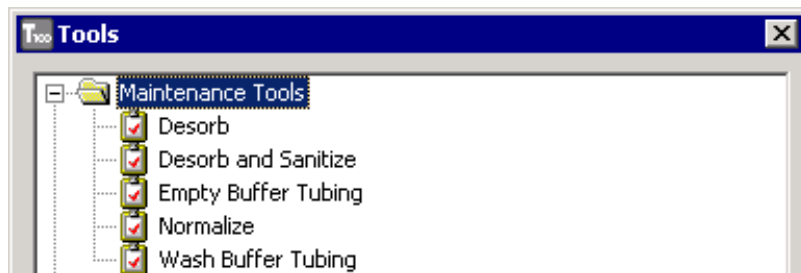

Figure B-5. Maintenance Tools.

#### *Desorb*

Run the maintenance tool **Desorb** to clean the sample tubing and IFC channels at least once a week, or more often if proteins and other substances used show a tendency to adsorb to the walls of the flow system (often revealed by carry-over problems in assays).

Required solutions: BIA desorb solution 1  
BIA desorb solution 2  
deionized water

Sensor Chip Maintenance is required for the procedure. The solutions used in the **Desorb** procedure may damage the surface of sensor chips used for assays.

For some applications, a coating of protein on the tubing and IFC channel walls helps to give reproducible results, and the first few cycles after **Desorb** may be unreliable. If you observe this behavior, run **Desorb** when you change your protein system rather than once a week.

Note: Do not run **Desorb** at analysis or sample compartment temperatures below 20 °C. BIA desorb solution 1 precipitates at low temperatures.

#### *Desorb and Sanitize*

To prevent microbial growth in the instrument, keep a high standard of hygiene in the solutions used.

Run the maintenance tool **Desorb and Sanitize** at least once a month, to remove adsorbed material and disinfect the system. All buffer tubing is washed, and buffer tubes B, C and D are emptied during the procedure.

Sensor Chip Maintenance is required for the procedure. The solutions used in the **Desorb and Sanitize** procedure may damage the surface of sensor chips used for assays.

Required solutions: BIA desorb solution 1  
BIA desorb solution 2  
BIA disinfectant solution  
deionized water

Note: Do not run **Desorb and Sanitize** at analysis temperatures below 20 °C. BIA desorb solution 1 precipitates at low temperatures.

### *Empty Buffer Tubing*

The maintenance tool **Empty Buffer Tubing** washes and empties all buffer tubing. Run this tool when you have used buffer tubes **B**, **C**, or **D**, and do not intend to use them any more.

Required solutions: 70% ethanol  
deionized water

### *Wash Buffer Tubing*

Run this tool when you change from buffers containing substances that tend to adsorb to the tubing, e.g. detergent or BSA.

One of the buffer tubes, or all buffer tubes are washed during the procedure. The selection is made at the start of the procedure.

Required solutions: BIA desorb solution 1  
BIA desorb solution 2  
deionized water

Sensor Chip Maintenance is required for the procedure. The solutions used in the **Wash Buffer Tubing** procedure may damage the surface of sensor chips used for assays.

Note: Do not run **Wash Buffer Tubing** at analysis temperatures below 20 °C. BIA desorb solution 1 precipitates at low temperatures.

### B.3.5 Normalizing the detector

#### *At the start of a run*

Check the **Normalize detector** option in the **System Preparations** dialog, which appears before the start of each run. This procedure adjusts the detector response to compensate for slight differences in individual sensor chips. For best performance, run this procedure once for each new chip. The procedure can either be run before immobilization or before the first run using the immobilized chip. Normalization injects a solution of 70% glycerol in water over the chip surface.

Required solution: BIAnormalizing solution

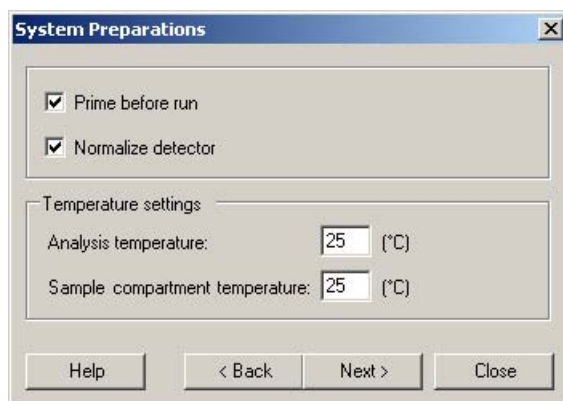

**Figure B-6.** *System Preparations dialog.*

#### *At any other time*

Run **Maintenance Tools:Normalize** to normalize the detector response for all flow cells, when changing sensor chip.

Note: Run **Normalize** with the correct sensor chip docked. Do not run **Normalize** with Sensor Chip Maintenance.

## B.4 User service operations

Tools for user service operations are available under **Test Tools** and **Service Tools** in the **More Tools** menu.

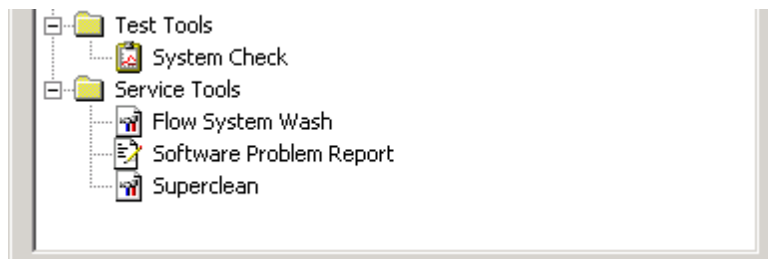

**Figure B-7.** *Test Tools and Service Tools.*

### **B.4.1 System check**

This procedure performs a comprehensive check of system performance, using a standard sucrose solution (BIAtest solution), which is provided in the Biacore Maintenance Kit, type 2.

Total run time is about 1 hour. It is recommended to perform a system check once every month. If you experience problems with the system, run **System Check** before calling Biacore Service.

Use a new Sensor Chip CM5 for this procedure.

Required solutions: BIAtest solution  
HBS-N buffer

To perform a system check:

1. Choose **Tools:More Tools** and select **System Check**. Click **Start**.

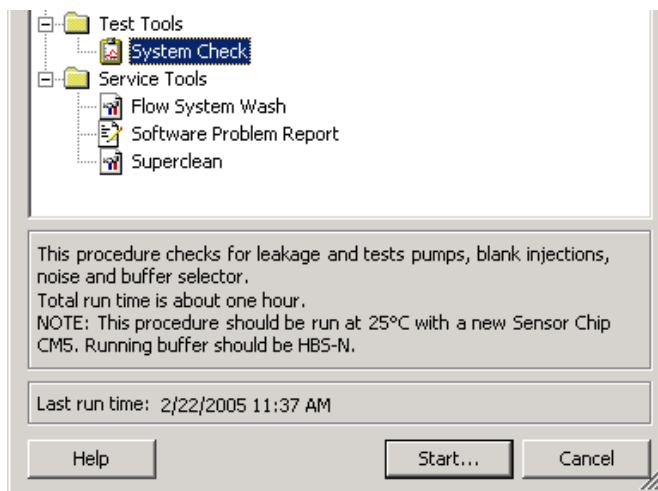

2. In the **System Check** dialog, click **Next** to proceed. Follow the instructions on the screen to prepare and start the system check. The analysis temperature will be adjusted as part of the procedure.

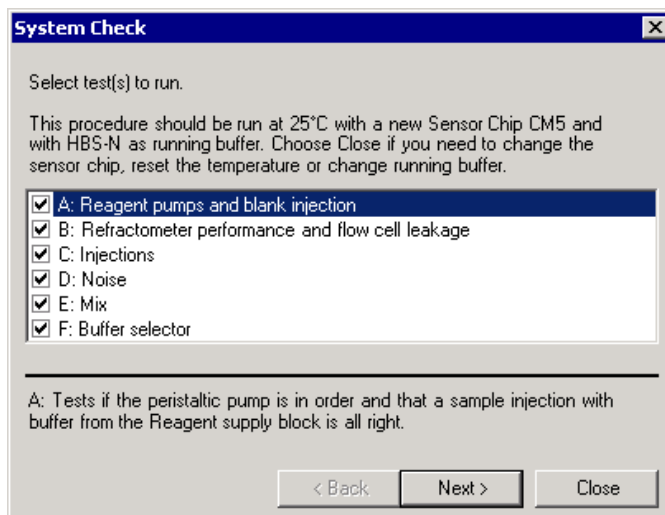

3. The results of the system check are displayed automatically after the run. OK indicates a passed test, a failed test is indicated by BAD.

*System check results*

<b>Test</b>	<b>Likely cause of failure</b>	<b>Explanation/Action</b>
<b>A: Reagent pump</b> Water Buffer	Air in injections 1 and 2	The clamp on the upper peristaltic pump was not fastened.
	Air in single injection	Tubing squeezed or not fully inserted into buffer or water.
	Blank injection deviates from baseline	Deposits in the liquid supply block.
<b>B: Refractometer</b> Fc1 Fc2 Fc3 Fc4	Too low values	A new chip was not used. May also result in too large spread in baseline level.
	Too high or too low values	Wrong buffer. Wrong temperature.
	Flow cell leakage too large	Bad IFC. Call Biacore Service.
<b>C: Injections</b> Fc1 Fc2 Fc3 Fc4	Leaks in syringe pump or other parts of flow system	Call Biacore Service.
<b>D: Noise</b>	Drifting baseline	A new chip was not used.
		Temperature not stable. Call Biacore Service.
<b>E: Buffer selector</b> Buffer A Buffer B Buffer C Buffer D	Tubing in wrong bottles	Check that the buffer tubes are inserted in the correct bottles.
	Buffer selector not working	Call Biacore Service.
	Leaking syringe pump	Call Biacore Service.
<b>F: Mixing</b> Mix1 Mix2 Difference	Leaks in syringe pump or other parts of flow system	Call Biacore Service.
	Salt deposits on the needle	Clean the needle (Section B.4.5). Check that vials are clean and unused.

**Table B-3** System check diagnostics.

### B.4.2 Superclean

The **Superclean** procedure washes the flow system and denatures proteins to increase their solubility. Warm water is used as running buffer to increase the solubility of most biomolecules and salt.

Run the maintenance tool **Desorb and Sanitize** followed by **Superclean** if you suspect that the **Desorb and Sanitize** procedure is not sufficient to clean the flow system. Total runtime is about 1.5 hours.

Sensor Chip Maintenance is required for the procedure. The solutions used in the **Superclean** procedure may damage the surface of sensor chips used for assays.

Required solutions are listed in Table B-4.

Proteins	Small molecules
deionized water at 50 °C 1% acetic acid 0.2 M sodium bicarbonate 6 M guanidine-HCl 10 mM HCl	deionized water at 50 °C 1% acetic acid 0.2 M sodium bicarbonate 50% DMSO 10% DMSO

**Table B-4.** Required solutions for the Superclean procedure.

### B.4.3 Opening the sample compartment

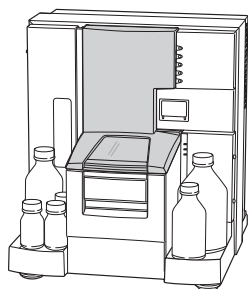

#### **WARNING!**

Always turn off the mains power switch before opening the sample compartment door. The instrument must be off as long as the sample compartment door is open.

If you need to access the needle and the liquid supply block for cleaning:

1. Choose **Tools:Stop Standby** if the instrument is in Standby mode.
2. Remove any microplate and reagent rack from the sample compartment. Make sure that the rack tray is fully retracted and the sample compartment is closed.
3. Turn off the **MAINS POWER** switch at the rear right of the instrument.
4. Open the sample compartment door: use a flat head screwdriver to turn the lock screw 1/8 turn counter-clockwise.

Note: The sample compartment door swings upwards when released. Do not lean over the instrument when you open the sample compartment door.





**Figure B-8.** Opening the sample compartment door.

#### **B.4.4 Cleaning the sample compartment**

**WARNING!**

The injection needle is sharp and may penetrate protective latex gloves. Take particular care if hazardous agents have been used.

1. Remove the insulation plate at the back of the sample compartment.
2. Remove spillage from the sample compartment with water or ethanol as required.
3. Dry with a lint-free cloth.

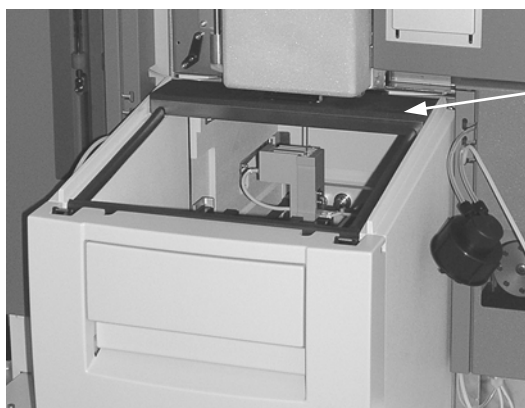

Insulation plate

**Figure B-9.** The sample compartment door opened.

#### **B.4.5 Cleaning the needle and the liquid supply block**

If salt residues have accumulated:

1. Wipe the needle and the liquid supply block with a wet cloth.
2. Replace the insulation plate at the back of the sample compartment.
3. Pull down the sample compartment door, and close the door by pressing it down until it snaps into position.
4. Start the instrument and the software.
5. Run **Tools:Prime** to wash the needle and the liquid supply block.

Required solutions: Running buffer

#### **B.4.6 Removing the sample compartment box**

If required, the sample compartment box can be removed for better access to the sample compartment.

To remove the sample compartment box:

1. Open the sample compartment (see Section B.4.3).
2. Pull out the tubing from the water bottle and remove the bottle.
3. Remove the cap from the waste bottle and remove the bottle.
4. Pull out the tubing from the buffer bottles and remove the bottles. Place the tubing ends in the holder inside the left pump compartment.
5. Remove the buffer tray and the waste and water tray.
6. Use two 2.5 mm screwdrivers to press the two catches inside the sample compartment box (see Figure B-10). Pull the box out of the instrument.

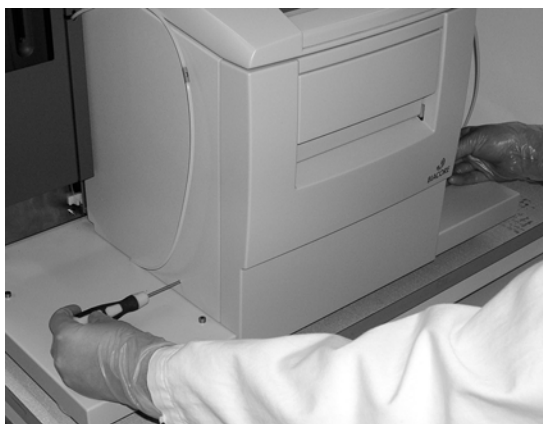

**Figure B-10.** *Opening the sample compartment box.*

***Replacing the sample compartment box***

1. Push the sample compartment box along two guide rails into the instrument. Press until it locks into position.
2. Replace the buffer tray and the waste and water tray.
3. Pull down the sample compartment door, and close the door by pressing it down until it snaps into position.
4. Make sure that no tubing is in the way, then close the door by pressing it onto the sample compartment box.

## B.5 Shutting down the system

---

### **B.5.1 Standby**

When not in use, Biacore T100 should be left in standby mode. The instrument maintains a low flow of liquid through the flow system. The default standby period is 4 days.

To set the instrument in standby:

1. Fill a bottle with sufficient distilled and filtered water for the standby period. Fit a cap onto the bottle and place it on the buffer tray. Insert the tube marked **A** into the water bottle. Liquid consumption during standby is approximately 65 ml/24 h
2. Empty the waste bottle.
3. Check that there is sufficient water in the bottle on the waste and water tray.
4. Choose **Tools:Standby**.
5. Make sure that there is sufficient liquid before leaving the instrument.

Note: Biacore recommends that you use distilled and filtered water instead of buffer to minimize salt deposits. However, if an immobilized sensor chip is docked and will be used later, buffer may be necessary to preserve the sensor surface during standby.

If the instrument will be unused for a long period of time, follow the instructions for shutdown in Section B.5.2.

### **B.5.2 Shutdown**

To shut down the instrument completely:

1. Run **Desorb and Sanitize** to clean the flow system.
2. Eject the rack tray carriage and remove the rack tray.

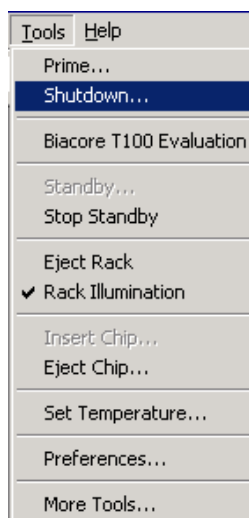

3. Prepare a bottle of distilled and filtered water, and a bottle of 70% ethanol. Choose **Shutdown** from the **Tools** menu. Follow the instructions on the screen.

The procedure flushes the flow system and then empties the IFC of liquid. Total run time is about 20 minutes.

4. When instructed, open the right door and open the tube clamp of the peristaltic pump to relieve the pressure on the pump tubing (see Figure B-11 below).
5. Exit from Biacore T100 Control Software by selecting **File:Exit**. Select **Exit the software**.
6. Open the sample compartment door and clean the needle and liquid supply block if necessary (Sections B.4.3 to B.4.5).
7. Remove bottles, the waste cap assembly and the bottle trays. Seal the loose tubing ends, for instance by wrapping them in plastic bags.

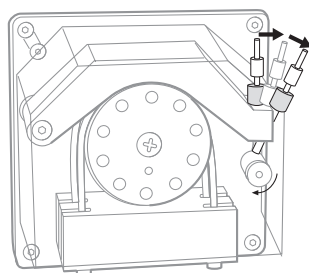

**Figure B-11.** *Opening the tube clamp. To completely open the clamp, flip the lever to the second position, until it touches the compartment wall.*

**Caution!**

Before re-starting the system, make sure that the tube clamp is properly fastened.



## C. Troubleshooting

This chapter gives a brief guide to troubleshooting procedures for problems with Biacore T100.

### C.1 System-related problems

---

#### **C.1.1 Instrument hygiene**

A fundamental requirement for trouble-free operation of Biacore T100 is that the system is kept clean and is maintained regularly according to the following guidelines:

- Always use fresh buffer and distilled water. Filter both buffer and water through a 0.22 µm filter to remove particles.
- Follow the recommended maintenance procedures as described in Appendix B. Do not ignore maintenance schedule reminders (Section B.1).
- If the system is used with particularly “sticky” molecules or complex mixtures such as serum, clean the flow system thoroughly after each run.
- Leave the system in standby mode with freshly filtered distilled water or buffer when not in use, or run the **Shutdown** procedure to empty the flow system. Do not leave the instrument with liquid standing still in the flow system.
- Do not take the sensor chip out of its protective cassette. Dust or other particles on the sensor chip surface can seriously interfere with detection.

#### **C.1.2 Instrument considerations**

- If the PC does not seem to communicate with the instrument, check that the communication cable is properly connected (Section A.5.3).
- Make sure there is adequate ventilation around at the instrument site (Section A.4)
- Check the accessible tube fittings on the pumps, buffer selector valve and degasser regularly for leaks (Section B.3.3).

- Make sure the clamp on the peristaltic pump is properly closed at the start of a run (Section 3.2.2). If the clamp is not closed, buffer and water will not be supplied properly to the liquid supply block.

### **C.1.3 Buffer considerations**

- Make sure that the correct buffer tubing is inserted into the buffer bottle(s). If you are only using one buffer, you should use buffer tubing A (Section 3.2.2). The syringe pumps will be empty and the response will be out of range if no buffer is supplied to the flow cell.
- Check that there is sufficient buffer in the buffer bottle(s) and water in the water bottle at the start of a run.

### **C.1.4 Sample considerations**

- Make sure that you have sufficient sample and reagent in the vials and microplate. The volumes specified in the software (See the Biacore T100 Software Handbook) are minimum volumes with due consideration for dead volumes in different vials and microplates. Larger volumes may be needed if you have problems with injection of air in of sample or reagent injections.
- Use only recommended vials and microplates (Appendix D).
- Use only recommended septa for vials and adhesive foil for microplates. Sample evaporation from uncovered samples will both affect the sample concentration and reduce the volume, possibly resulting in injection of air. Use of unsuitable adhesive foil may block the autosampler needle with adhesive.

### **C.1.5 For further help**

If you are experiencing instrument-related problems and are unable to identify and/or correct them, run **System Check**, then contact your Biacore Service representative.

## **C.2 Assay-related problems**

---

### **C.2.1 Ligand considerations**

Loss of ligand activity on the surface of the sensor chip is a common source of application problems.

- If you cannot immobilize sufficient ligand with retained analyte-binding capacity, try alternative immobilization methods or use a



capturing approach. In some cases it may be sufficient to perform immobilization at a milder pH, or to avoid exposure of the ligand to immobilization buffer as far as possible. The immobilization wizard supports dilution of ligand into immobilization buffer immediately before injection, for ligands that do not withstand extended exposure to immobilization conditions.

- Make sure that the ligand withstands regeneration conditions without loss of activity. If you cannot find suitable regeneration conditions, consider using a capturing approach so that you use fresh ligand on the surface for each analysis cycle.
- If you plan to store sensor chips with immobilized ligand for later use, perform control experiments to establish that the ligand retains activity in the storage conditions.
- Make sure you choose the correct flow path for a run. If you inject samples over a flow cell where no ligand is immobilized, you will not see significant binding.

### **C.2.2 Sample considerations**

- Make sure the samples do not precipitate at the concentrations and buffer conditions used. Even micro-precipitation on the surface can seriously disturb the detection, and is generally seen as excessive noise and irregularities in the sensorgrams.
- Where possible, samples should be prepared in running buffer or similar conditions. Drastic changes in buffer composition between running buffer and sample can introduce artefacts that may be difficult to interpret.

### **C.2.3 For additional help**

Several Biacore publications provide guidance on design and execution of experiments:

- The Biacore Sensor Surface Handbook provides in-depth consideration of the principles and practice of sensor chip preparation and regeneration.
- The Biacore Concentration Analysis Handbook describes principles of concentration measurements with Biacore, including considerations of assay design and validation.
- The Biacore Advisor Tutorial interactive CD provides an introduction to experimental design for both new and more experienced users. This publication covers basic principles, sensor surface preparation, experimental design and evaluation for

specificity, multiple binding, concentration, kinetic and affinity studies.

- The Biacore Advisor Kinetics interactive CD offers a theoretical and practical guide to development and analysis of kinetic experiments, including preparation of sensor surfaces, pilot experiments, general recommendations for experiments and data evaluation, as well as discussion of common problems and troubleshooting.
- The Immobilization and Regeneration database on [www.biacore.com](http://www.biacore.com) contains protocols for specific immobilization and regeneration situations developed by scientists from Biacore as well as by Biacore users around the world.

If you cannot solve your assay-related problems with the information provided in these publications, contact your Biacore Application Support representative.

## D. Specifications

### D.1 General

---

Automation	48 h unattended operation
Molecular weight detection	> 100 Da (ligand and analyte dependent)
Sample volume	10-425 $\mu$ l (application dependent)
Sample/reagent capacity	One 384 well or one 96 well microplate + 33 reagent vials, or 73 vials for samples and reagents
Analysis time per sample	Typically 2-15 min

### D.2 Processing unit

---

Dimensions (see also Fig. A-1) W×D×H	600×615×690 mm
Net weight	60 kg
Weight incl. packing	80 kg
Mains requirements	Autorange 100–240 V ac, 50–60 Hz, protective earthing
Fuses	2×T6.3AH
Power consumption	Max. 6.3 A
Ambient temperature range	18-33°C
Ambient humidity	≤85 %RH
Analysis temperature	4-45°C, max. 20°C below ambient temperature
Safety standard, EMC	See Section 1.5

### D.3 Flow cells

Number of flow cells	4
Flow cell height	Approximately 0.04 mm
Flow cell volume	approximately 0.06 $\mu$ l

### D.4 System controller and software

PC operating system	Microsoft® Windows® 2000 or XP (Professional)
Interfacing	Possibilities for import of sample data and export of results, e.g. to LIMS

### D.5 Reagent racks

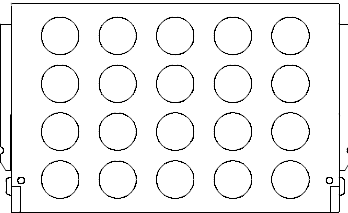
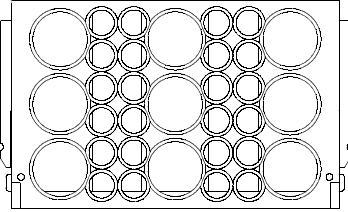
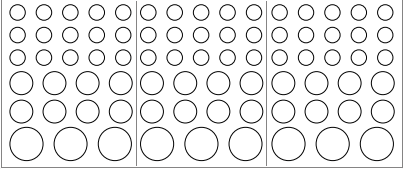
<p><b>Reagent rack, type 1</b> 20 vials, diam. 11 mm (1.5 ml Eppendorf)</p>	
<p><b>Reagent rack, type 2</b> 9 vials, diam. 16 mm (4.0 ml) 24 vials, diam. 7.5 mm (0.8 ml)</p>	
<p><b>Sample and reagent rack</b> 9 vials, diam. 16 mm (4.0 ml) 24 vials, diam. 11 mm (1.5 ml Eppendorf) 45 vials, diam. 7.5 mm (0.8 ml)</p>	

**Table D-1.** Reagent rack specifications

## D.6 Microplates

---

Microplate formats	96 or 384 shallow plates, conforming to SBS standard
--------------------	--

## D.7 Liquid containers

---

### D.7.1 Buffer tray

Running buffer	1 × 1 l, 3 × 250 ml, screw caps with gasket
----------------	---

### D.7.2 Waste and water tray

Waste	2 l (must be of the same type as the one delivered with the system). Special screw cap with two tube fittings.
Water	500 ml, screw cap with gasket

## D.8 Chemical resistance

---

This section gives some general guidelines concerning chemical resistance for Biacore T100 components. Regarding exposure to solutions not covered by these guidelines, contact your Biacore representative for recommendations.

The flow system and sensor chip are the only parts of Biacore T100 that come into contact with solutions. The guidelines in this section relate to tubing and connectors, selector valves, connector block, IFC and sensor chip.

**Note:** In most analysis situations, the ligand attached to the sensor surface limits the chemical resistance of the system as a whole.

In general, the flow system components withstand long-term exposure to common aqueous buffer solutions used in biochemical laboratories. Table D-2 below lists compatibility with other common substances.

Concentrated organic solvents as well as long-term exposure to extremes of pH (<3 and >11) should be avoided. For solutions with *short-term* compatibility, do not use as running buffer or for injections longer than 10 minutes. Solutions classed as *long-term* compatible may be used as running buffer.

Solution	Concentration	Compatibility
Acetonitrile	50%	Short term
Dimethyl formamide (DMF)	50%	Short-term
Dimethyl sulphoxide (DMSO)	50% 10%	Short-term Long-term
Ethanol	70% 10%	Short-term Long-term
Ethylene glycol	100%	Short-term
Formic acid	70%	Short-term
Formamide	40%	Long-term

**Table D-2.** *Chemical resistance.*

## E. Technical description

This appendix gives a brief description of technical aspects of Biacore T100.

### E.1 Detection principle

#### E.1.1 Surface plasmon resonance

Biacore T100 exploits the phenomenon of surface plasmon resonance (SPR) to detect and measure analyte. SPR is a phenomenon that occurs in thin conducting films at an interface between media of different refractive index.

Under conditions of total internal reflection, the light leaks an electric field intensity called an *evanescent wave field* across the interface into the medium of lower refractive index, without actually losing net energy.

The amplitude of the evanescent field wave decreases exponentially with distance from the surface, and the effective penetration depth is about half the wavelength of the incident light.

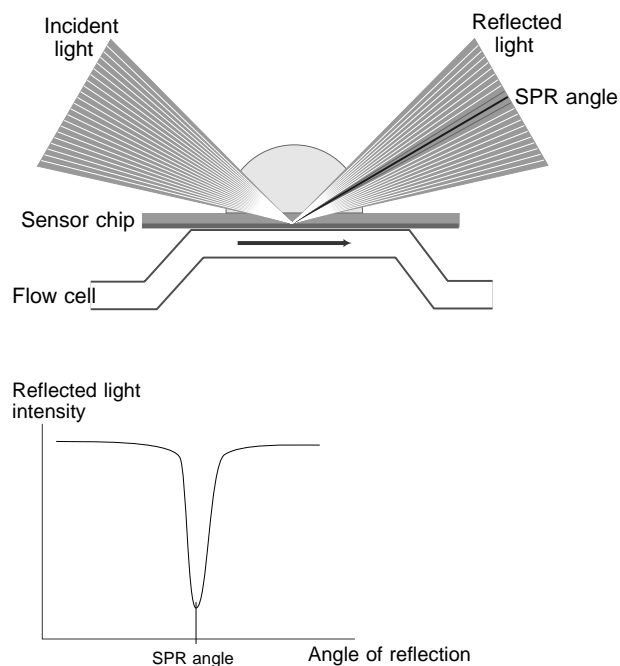

**Figure E-12.** The SPR principle.

At a certain combination of angle of incidence and energy (wavelength), the incident light excites *plasmons* (electron charge density waves) in the gold film. As a result, a characteristic absorption of energy via the evanescent wave field occurs and SPR is seen as a drop in the intensity of the reflected light (Figure E-1).

Because the evanescent wave field penetrates the solution, conditions for this resonance effect are very sensitive to the refractive index of the solution within the effective penetration depth of the evanescent field. Changes in solute concentration at the surface of the sensor chip cause changes in the refractive index of the solution, which can be measured as changes in the SPR conditions.

**Note:** The reduced intensity of reflected light is not caused by light absorption in the sample in the conventional (transmission spectroscopy) sense. The light used in Biacore T100 is totally internally reflected inside the optical unit, and it is the evanescent wave that penetrates the sample. Consequently, measurements may be made on turbid or even opaque solutions, without interference from conventional light absorption or scattering by the sample.

### **E.1.2 What SPR measures**

In the configuration used in Biacore T100, the SPR response is a measure of the refractive index of the solution within the penetration distance of the evanescent field wave. This distance is small (about 300 nm) in relation to the volume of sample used, so that effectively SPR measures the refractive index at the surface of the sensor chip.

The refractive index of the solution varies with the solute content. When the detecting molecule is attached to the sensor chip or when analyte binds to the detecting molecule, the solute concentration at the sensor chip surface increases, leading to a change in the SPR signal.

The response measured in Biacore T100 is related to the mass of analyte bound and is largely independent of the nature of the analyte. Refractive index contributions for different solutes are additive, so that the amount of detecting molecule attached and the amount of analyte bound can both be measured with the same detection principle.



## E.2 Flow system

Two high performance syringe pumps and one peristaltic pump handle the distribution of buffer and water to the IFC and the liquid supply block.

One syringe pump maintains a low flow of buffer through the IFC. The second syringe pump is used for aspiration of samples and reagents, and precision delivery to the sensor chip surface via the IFC. The system switches automatically between these pumps as required.

The peristaltic pump continuously supplies buffer and water to the liquid supply block. The buffer is used for washing the injection needle, in position S1 of the liquid supply block. The buffer flow also helps keeping the liquid supply block clear of precipitated buffer.

Water is used for rinsing the needle (position S2) and the liquid supply block itself.

Effluent from the IFC and the liquid supply block is conveyed to the waste bottle.

Figure E-13 shows the principle of the flow system.

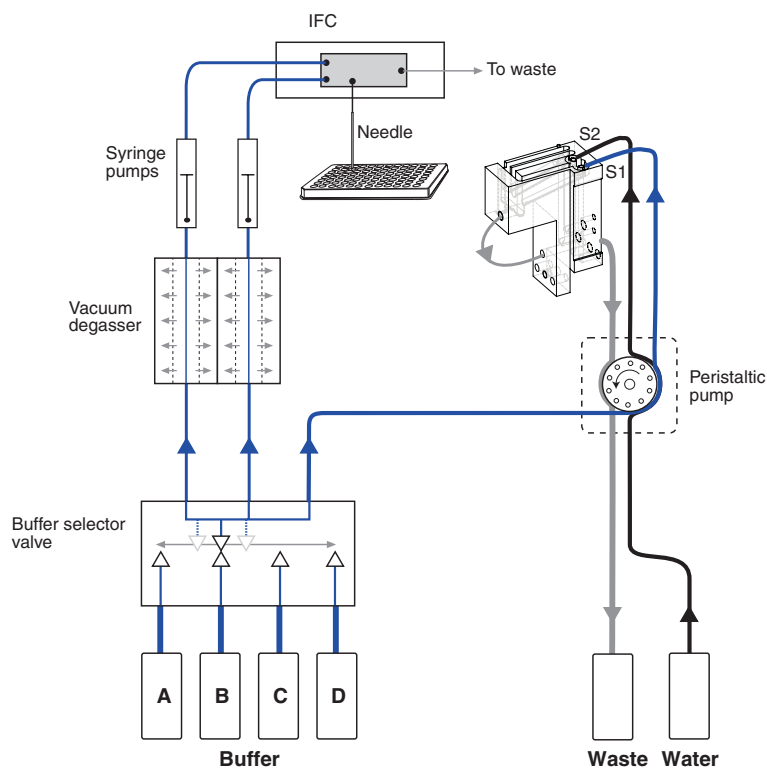

**Figure E-13.** Principle of the flow system.

### **E.2.1 Buffer degasser**

The degasser consists of independent vacuum chambers, each containing membrane tubing, which is permeable to small gas molecules.

Each of the two buffer tubes from the selector valve is connected to a separate vacuum chamber. A small vacuum pump maintains a low pressure in the vacuum chambers, thereby drawing gas molecules through the membrane tubing.

Valves in the degasser switch pump input between the vacuum chambers and atmosphere. This keeps the pump clean and increases the service life of the degasser. An active carbon filter provides added protection for the vacuum pump.

### **E.2.2 Cooling unit**

A cooling unit based on Peltier elements is built into Biacore T100. The cooling unit is located at the bottom of the instrument, behind the sample compartment.

The cooling unit normally requires no user maintenance. Condensate water may occasionally drip from the cooling unit during long runs at low temperatures.

# Index

- A
  - adhesive foil, 15
  - air bubbles, 31
- B
  - basic operation
    - overview, 23
  - Biacore T100 instrument
    - general description, 7
  - Biacore T100 system, 1
  - buffer selector valve, 18
- C
  - changing reagent racks, 33
  - chemical resistance, 69
  - cleaning
    - flow system, 50
    - instrument, 47
    - needle, 58
    - sample compartment, 57
  - computer ports, 13
  - contamination with biohazards, 43
  - control software
    - installation, 42
  - cooling unit, 49, 74
- D
  - degasser, 18, 74
  - Desorb**, 50
  - Desorb and Sanitize**, 50
  - detecting molecule, 72
  - detection system, 20, 71
  - diagnostics, 55
  - disposal procedures, 5
  - docking the sensor chip, 27
- E
  - electromagnetic compatibility
    - European directive, 6
  - emergency stop, 5
  - evanescent wave, 71
- F
  - flow system, 73
    - cleaning and disinfecting, 51

## H

- hazards, 2
- hygiene, 63

## I

- IEC/EN standards, 6
- inserting a sensor chip, 27
- installing control software, 42
- installing the rack tray, 35
- instrument transport
  - preparations, 60
- integrated microfluidic cartridge (IFC), 13, 19

## L

- leaks, 48
- ligand, 64
- liquid handling system, 13
  - initiating, 29
- lithium backup battery, 5
- low voltage devices
  - europaean directive, 6

## M

- mains inlet, 41
- mains power, 40
- mains power switch, 12
- maintenance
  - accessories, 47
  - overview, 43
  - safety requirements, 43
  - user, 44
- maintenance kit, 44, 46
- Maintenance Kit, 44
- Maintenance Tools**, 43
- microtiter plates, 15, 69
- moving the instrument, 40

## N

- normalizing the detector, 52

## O

- online help, 2

## P

## PC

- connection to Biacore T100, 41
- plasmons, 72
- power requirements, 40
- preparing buffers, 24
- preparing reagents, 34
- preparing samples, 31
- preventing microbial growth, 50

preventive maintenance, 45  
processing unit  
specifications, 67, 68

## R

rack cover, 33, 34  
rack tray  
ejecting, 30  
installing, 35  
rating information, 2  
ready lamp, 12, 23  
reagent rack, 15, 68  
reagent supply block, 17  
refractive index, 71  
removing adsorbed proteins, 50  
restart Biacore T100, 6  
Run lamp, 12  
running buffer, 25, 69

## S

safety  
information, 2  
instructions, 4  
labels, 3  
sample compartment, 10  
sensor chip, 21  
docking, 27  
undocking, 27  
Sensor Chip CM5, 53  
Sensor Chip lamp, 12  
Sensor Chip Maintenance, 50, 51  
sensor chip port, 11  
serial communication, 41  
serial port, 13  
Series S Maintenance Kit, 46  
**Service Tools**, 43  
software  
installation, 42  
solutions  
parts in contact with, 69  
space requirements, 39  
specifications, 67  
SPR, 71  
standby, 37, 60  
starting the system, 23  
stop run, 5  
superclean, 56  
surface plasmon resonance, 71  
system check, 53  
System lamp, 12

- T
- technical specifications, 67
- temperature
  - ambient, 40
  - analysis, 21
  - lamp, 12, 23
  - sample compartment, 22
  - setting, 29
- Tools
  - eject rack, 30
  - shutdown, 61
  - standby, 60
  - system check, 53
- U
- undocking the sensor chip, 27
- W
- waste tray, 9
- water tray, 9





**BIACORE**

**[www.biacore.com](http://www.biacore.com)**

BR-1006-47